

# Design of a Wing with Bell-shaped Span-load using VLM Method

Vinayak Bembrekar<sup>1</sup>, Akshay Rasane<sup>2</sup>, Ajay Jadhav<sup>3</sup>, Om Vaishnav<sup>4</sup>, Sandip Mirdude<sup>5</sup>

<sup>1</sup>Assistant professor, Dr. D. Y. Patil College of Engineering, Akurdi, Pune.

<sup>2,3,4,5</sup> B.E Mechanical students, Dr. D. Y. Patil College of Engineering, Akurdi, Pune.

## Abstract

The bell-shaped span-wise load distribution in aircrafts has a potential of eliminating the problem of adverse yaw in aircrafts. This study focuses the reduction in induced drag that could be achieved in the such a model when compared with conventional elliptical span-wise load distribution. The analysis of this model was performed using the vortex lattice method, to determine the flight characteristics and the distribution of Lift and drag forces acting the wing.

## Keywords

Bell shaped span load, Adverse yaw stabilisation, flying wing, Induced drag, Blended wing body, Vortex lattice method.

## I. INTRODUCTION

The span-wise load distribution or Span-loads in aircrafts is the distribution of the resultant forces acting on the wing of the aircrafts. There are three major types of span-loads in aircrafts as follows:

1. Rectangular span-wise load distribution.
2. Elliptical span-wise load distribution.
3. Bell-shaped span wise load distribution.

The rectangular span wise load distribution is generally not used in aircrafts. The elliptical span-wise load distribution is most used in current aircrafts as it creates minimum induced drag [1]. The elliptical span load was derived by Ludwig Prandtl in 1921 and since then it has been the primary and most prominent used span load system since then. Though it creates less induced drag it still has the problem of adverse yaw and hence needs the vertical tail to correct it. This vertical tail does not take part in lift creation and hence theoretically should not be required, and this is also confirmed by the fact Birds don't have vertical tails.

The Aircraft designed with bell-shaped span load has a potential of eliminating the problem of adverse yaw and reduction in induced drag. For such an aircraft the complexity of vertical tail would not

be needed. Also, this would result in significant decrease in weight of the aircraft.

## II. ADVERSE YAW

Adverse yaw is tendency of aircrafts to yaw the opposite direction of the roll. The rolling moment in desired direction is achieved by increasing lift on the one side of the wing (opposite side of the direction of turn to be achieved), due this however, the induced drag on that side of the wing also increases and hence resulting in opposite yawing moment to the direction of the roll. To compensate this 'adverse yaw' we need to apply an opposing force in the desired direction. Hence this task is done by the vertical tail. This is the reason why current aircrafts need vertical tail. Otherwise the vertical tail or rudder has no participation in lift generation.

## III. BELL-SHAPED SPAN-LOAD

Bell-shaped span-wise load distribution was also discovered by Ludwig Prandtl in 1933 [2]. The bell-shaped span-load is given by the equation below,

$$L = (1 - x^2)^{3/2} \dots\dots\dots [3]$$

Where L is local load in the wing and x is span location between 0 to 1. By this the load distribution can be calculated and approximated across a given span. The lift distribution in such span-load is shown in figure below:

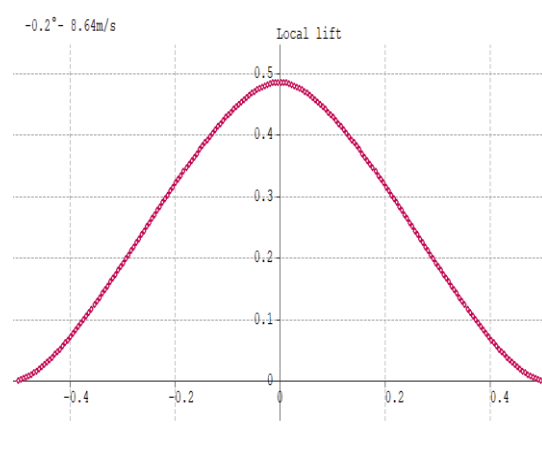

Fig.1 The bell-shaped lift distribution across the span

This span-load was used in the flying wing experiments of Horten brothers from 1935-1945 [4]. Their most significant model was the Ho 229 V3 jet aircraft produced in Germany during world war 2. The current research is also conducted in NASA Armstrong Flight research centre in California, by Albion H. Bowers named the Prandtl-d project [3]. This research shows promising reduction in induced drag and elimination of adverse yaw. This method if applied to current aircrafts it will result in more efficient aircrafts and it will result in decrease in fuel consumption of aircrafts. There will also be reduction in weight due to the elimination of vertical tail.

**IV. VORTEX LATTICE METHOD**

Vortex lattice method is a numerical method in Aerodynamics used in early stages of design of aircrafts. By this method we can estimate the forces of the lift, drag acting on the wing and can also estimate the distribution of these forces across the span. We can estimate the flow around the geometry of the wing by giving inputs of span, geometric twist, camber of air-foil, dihedral etc. Also, the position of vortex formation across the span due to the flow stream can be estimated.

For this design we have used a VLM software named XFLR5 which is an open-source software specifically made for university level research and for aeromodelling enthusiasts.

**V. DESIGN OF WING WITH BELL-SHAPED SPAN LOAD.**

To conform with the span-wise load distribution the lift must be varied along the span. This can be achieved by either applying geometric twist or aerodynamic twist. Geometric twist is done by changing angle of attack of the air-foil along the span. While the aerodynamic twist involves changing section of air-foil along the span that is different air-foil at each section.

We have incorporated non-linear geometric twist across the span to achieve this span-load distribution. NASA’s PRANDTL-D project also seems to have done the same.

A symmetric air-foil NACA 0012 is used in this model to avoid complexity. Following prerequisite data is considered before applying the twist:

Table.1. Preliminary characteristics of the wing

Sr.no	Characteristics	Values
1.	Wing Area	0.15m <sup>2</sup>
2.	Wing span	1m
3.	Root chord	0.250m
4.	Tip chord	0.05m

5.	M.A.C	0.175m
6.	Aspect ratio	6.667
7.	Taper ratio	0.2
8.	Sweep angle	24 degrees

The top view of the wing is shown below:

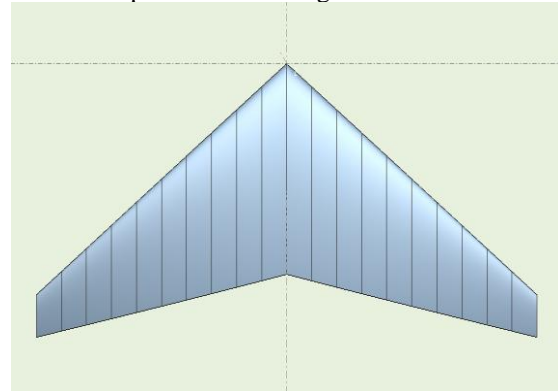

Fig.2. Layout of the wing

As the wing involves sweep angle, necessary sweep compensation is also given.

The geometric twist is to be across the span, hence the wing is discretised in equal parts for a symmetric wing. We have discretised the semi-span of wing in 10 equal parts to apply twist at each cross-section. Following are values of twist distribution across the span:

Table.2. Values of twist distribution

Sr.no	Span	Chord length	Angle of twist
1.	0	0.250m	7.56
2.	0.05m	0.230m	6.69
3.	0.1m	0.210m	5.81
4.	0.15m	0.190m	4.92
5.	0.2m	0.170m	4.01
6.	0.25m	0.150m	3.07
7.	0.3m	0.130m	2.11
8.	0.35m	0.110m	1.12
9.	0.4m	0.09m	-0.10
10.	0.45m	0.07m	-1.03
11.	0.5m	0.05m	-2.05

The following figure from view shows the twist incorporated in the wing:

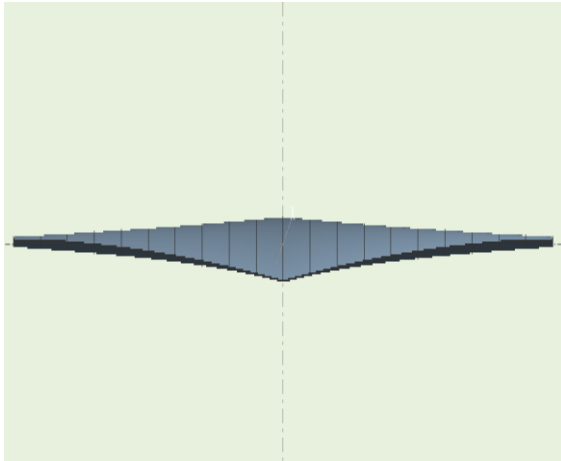

Fig.3. The geometric twist in wing.

The incorporated twist in the wing as seen above is non-linear.

### VI. ANALYSIS

The analysis is done using ring vortex method. As we need the results regarding induced aspects of drag the viscous effects are neglected. The Reynolds number is kept from 50,000 to 1,00,000. While the standard values of air-density are assumed. The fixed-lift type method of analysis is done. The velocity calculated is measured 8.64 m/s. The preliminary values of  $C_l$  and  $C_d$  are estimated by XFOIL plotter.

The graph of  $c_l$  vs  $c_d$  is shown in the graph below:

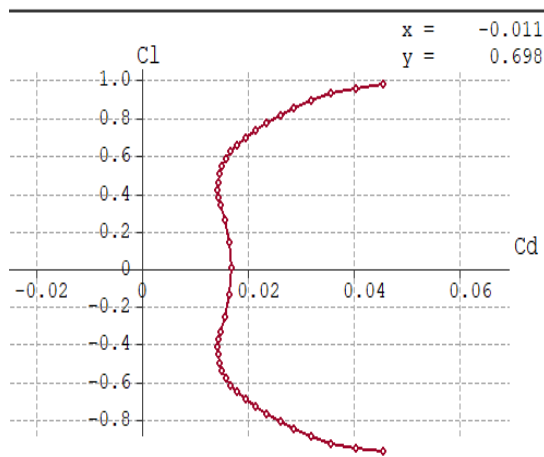

Fig.4. Coefficient of lift vs coefficient of drag.

### VII. RESULTS.

Results obtained are on basis that the viscous effects are not considered. The result is described on the characteristics that are specific for the bell-shaped span-load.

1. Induced drag: The induced drag is the most major concern in this as adverse yaw phenomenon is a product of the induced drag. In a wing with bell-shaped span-load the coefficient of induced drag distribution along span is shown in graph below:

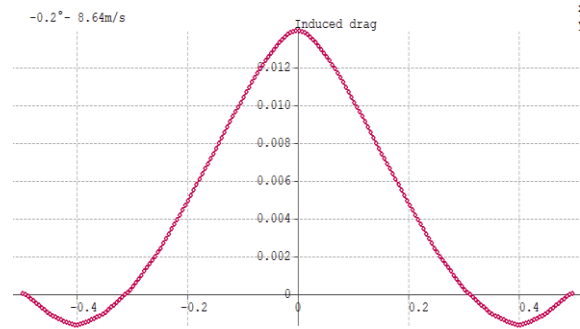

Fig.5. The induced drag distribution across the span

Notice the drag polar in the negative region of graph, technically the negative of drag force is the thrust force. This is most important feature of the sell-shaped span-load system.

2. The Downwash pattern: The downwash pattern is very specific for bell-shaped span-load as the downwash is linear and is then converted to up wash. While in the elliptical span load the downwash is more or less constant. The downwash pattern is shown in figure below:

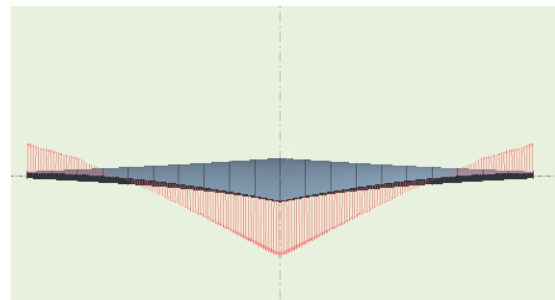

Fig.6. Downwash pattern in Wing

3. Vortex formation: The vortex formation is the formation of whirlpools created by the aircraft during flight. The Vortex formation in wing with elliptical span load takes place at the wing tips. In the wing with bell-shaped span-load however, this takes place at the position where downwash is converted to up-wash. This is also the position where the positive induced drag is converted to negative induced drag that is thrust. The vortex formation is seen in the figure below:

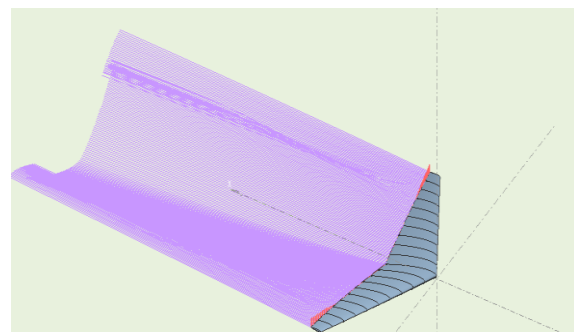

Fig.7. stream line acing on the body and resulting vortex formation

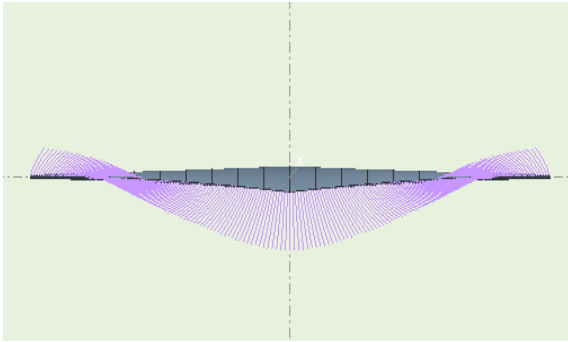

Fig.8. The position of the vortex formation.

As seen in above figure vortex formation that is overlapping of streamlines is clearly seen in figure above.

All the forces acting on the wing, including pressure distribution are shown in figure below:

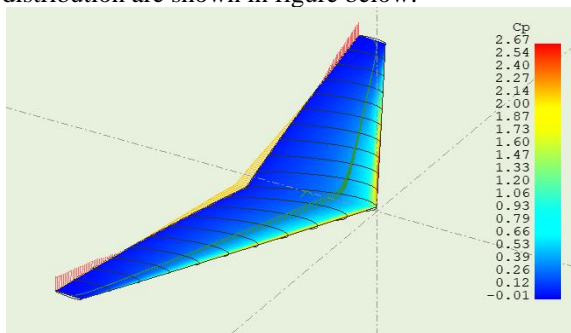

Fig.9. Pressure distribution on the wing

### VIII. CONCLUSION

The most important result in this study is the presence of negative induced drag in the tip section of the wing. This elaborates that if we place our control surfaces that is lift creating devices in this portion of the wing, the increase in lift would result in variation of induced drag in this negative region that is while taking a turn there will be assisting thrust on the tip for the co-ordinated turn. Hence by this the problem of adverse yaw could be solved and there will be no need of vertical tail. This was also seen in NASA's Prandtl-d experiment, called as 'proverse yaw'.

Also, when compared to the elliptical span-load the induced drag is minimum. This can be seen by comparing the graph below of induced drag coefficient vs the span for same amount of lift:

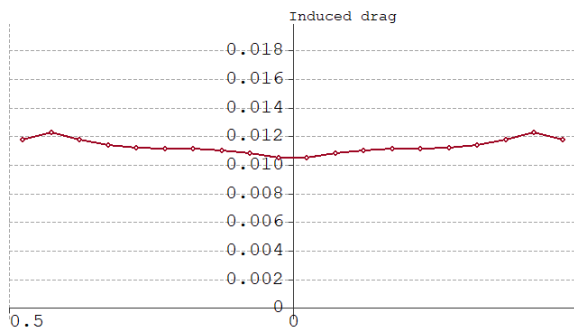

Fig.9. induced drag of wing with elliptical span-load

The above graph when compared with the fig.5 clearly shows that bell-shaped span load has relatively less induced drag than elliptical span-load.

If the average drag coefficient of both the graph is compared than we get approximately 35% decrease in induced drag than conventional aircrafts.

However, it must be noted that we are not considering the viscous effect of drag, which may be more due the geometrical twist induced in the wing. Also, the manufacturing challenges imposed due to such complexity in non-linear geometric twist are considerably high. This is what refrained us from making actual model of the wing to calculate the viscous effects.

Considering the positive gains from this type of span-load, the manufacturing difficulties could be overcome by newer manufacturing techniques.

### REFERENCES

- [1] Prandtl L (1921)Application of modern hydrodynamics to Aeronautics, NACA Report 116, Washington DC.
- [2] Prandtl L(1933) Uber TragFlugelKliensteninduzierwiderstandes, 1 VI 1933, Germany.
- [3] A.H. Bowers (march 2016) On wings of minimum Induced Drag (Nasa/tp-2016-2190727).
- [4] Lee R (2011) Only the wing: Reimarhorten's epic quest to stabilise all-wing aircraft, Smithsonian Institution of scholarly press, Washington DC.
- [5] Selinger p. with Scott J. story of hortens flying wings (1985).
- [6] Sachs G. (2012): Flying at no mechanical energy cost: Disclosing secret of flying albatross.
- [7] The spanwise distribution of lift for minimum induced drag of wing having a given lift and bending moment, NACA TN 2249, 1950.
- [8] Klein, Armin, and Sathy P. Vishwanathan. Approximate solution for minimum induced drag of the wing given structural weight. Journal of aircraft, feb 1975