

Reconfigurable Monopole Antenna with Notch Filter for UWB Applications: A Review

Neeraj Joshi¹, Vikas Kumar²

¹M.Tech. Scholar, ²Assistant Professor

^{1,2}Department of Electronics & Communication Engineering
Samalkha Group of Institutions, Samalkha, Haryana, India

Abstract- High data rate transmission is the need of modern wireless communication systems. Broadcast antennas are in demand as EM waves are transmitted at high frequency for high data rate transmission. Low profile, light weight, inexpensive, compact printed antennas are well suited for broadcasting for their ability to operate in broad frequency range. Printed microstrip antenna (Patch antenna) is used in various consumer applications meeting above mentioned requirements. Microstrip Patch Antenna (MPA) is easily integrated with Microwave ICs and Monolithic Microwave ICs because of its compactness. Reconfigurable Band Notch Antennas have attracted an interest of researchers due to its ability of rejection of electromagnetic interference (EMI) from various narrowband applications present in ultra wide band (UWB). In this paper, a portion of research available on Reconfigurable Band Notch Antenna in UWB applications has been studied and surveyed.

Keywords: EMI, Patch Antenna, DGS, Reconfigurable antenna, PIN diode

1. INTRODUCTION

Antenna spreads out a radio frequency (RF) signal generated in transmitter through space and gets it back at receiver. Defense and commercial applications like missiles, high performance spacecrafts, aircrafts, satellites, mobile radio and wireless communications require low profile, light weight, inexpensive, compact antennas. Microstrip patch antenna (MPA) meets the requirements of above mentioned wireless applications. In Microstrip patch antenna (MPA) there is a dielectric substrate with a printed conducting patch of copper on one side where as conducting ground on another side. The patch is a radiating element which may be rectangular, circular, elliptical, ring, triangular, any disc or ring sector etc. Different configurations of patch are shown in Fig. 1(a)-(f) respectively.

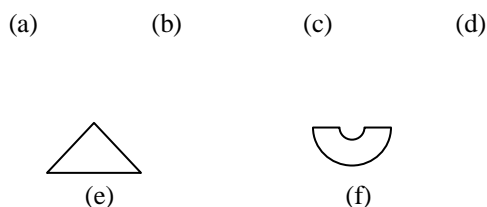
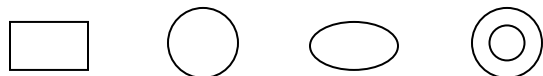

Figure 1: Configurations of patch antenna

These metallic patches are printed on a grounded substrate and are made conformal to be hidden inside various IC packages. Various operational limitations are on the performance of microstrip patch antenna like low efficiency and power, high Q, poor polarization purity, poor scanning etc. Microstrip antennas have various applications in broad frequency range from 100 MHz to 50 GHz but with very narrow frequency bandwidth (at most a few percentages). In 2002 Federal Communication Commission (FCC) commercialized the band 3.1 GHz-10.6 GHz for high frequency applications as ultra wide band (UWB).

UWB antenna is capable of using entire broad range of frequencies from 3.1 GHz to 10.6 GHz (Ultra wideband). EMI (Electromagnetic interference) from co-existing narrowband systems can be rejected by altering the antenna arrangement. UWB has attracted the interest of researchers as it has numerous applications for communication systems in Ultra wideband. Communication systems which co-exist with or within Ultra wideband are as follows:

- WLAN/WiFi, IEEE 802.11, 2.4/3.65/4.9/5/5.9 GHz.
- WiMAX, IEEE 802.16, 2.3/2.5/3.3/3.5 GHz.
- Bluetooth, IEEE 802.15.1 2.4-2.485 GHz.
- C-Band for satellite communication, 3.7-4.2GHz.
- X-band, 7.25-7.75/7.75-7.9/7.9-8.4/8.5-10.5 GHz.
- High Performance Radio LAN (HIPERLAN), 5.15-5.825 GHz.

These narrowband systems co-exist within UWB and cause interference to neighboring communication

systems. Hence UWB antennas are designed with band reject or band notch functions to generate antenna performance of our interest [1].

Transmission line, cavity and full-wave models are popular methods to analyze a microstrip antenna. Easiest and most popular model is transmission-line model because it gives a good physical insight. As per the transmission-line model, microstrip antenna is represented by two radiating slots (narrow apertures) of width w , height h , separated by a distance L . In the design procedure it is assumed that information includes dielectric constant (ϵ) of the substrate, resonant frequency (f) and height (h) of the substrate. The antenna design procedure is given as following: Practical width of the patch that leads to good radiation efficiencies is given as,

$$w = \frac{1}{2f\sqrt{\epsilon_0\mu_0}} \sqrt{\frac{2}{\epsilon+1}}$$

Where $\epsilon_0\mu_0 = c = 3 \times 10^8$ m/s and f = resonant frequency.

Effective dielectric constant of antenna for $w/h > 1$ is given as,

$$\epsilon_{\text{reff}} = \frac{\epsilon+1}{2} + \frac{\epsilon-1}{2} \frac{1}{\sqrt{1+12\frac{h}{w}}}$$

Extension of length ΔL is given as,

$$\Delta L = 0.412 h \frac{(\epsilon_{\text{reff}}+0.3)(\frac{w}{h}+0.264)}{(\epsilon_{\text{reff}}-0.259)(\frac{w}{h}+0.8)}$$

The actual length of the patch is calculated as,

$$L = \frac{c}{2f\sqrt{\epsilon_{\text{reff}}}} - 2\Delta L$$

Thus, the aim is to design a UWB antenna which minimizes the interference from co-existing narrowband applications and cover the broad frequency range of UWB.

In order to enhance the BW and introduction of rejection bands (stop bands), Defected Ground Structure (DGS) technique has emerged as a common choice. Varieties of defected structures have been used so far: rectangle, square, circle, dumbbell, L shape, V shape, spring, U shape, cross shape and polygons [2].

DGS has the same effect in design as a L-C resonance circuit. Value of inductance L and capacitance C depends upon the size and area of defected structure and are given by:

$$L_s = \frac{1}{\omega^2 c}$$

$$C_s = \frac{j\epsilon}{2z_0} \cdot \frac{1}{2\pi(f_0^2 - f^2)}$$

Reconfigurable stop band (reject band or notch) is dynamic research area. It efficiently utilizes most of frequency spectrum and works without interference with other co-existing narrowband systems. Reconfigurable reject band antennas may work in various modes depending upon the status of switching element (ON/OFF) and hence provide flexibility in antenna design. In this paper reconfigurable reject band UWB antennas are discussed. Band reject frequency can be made tunable continuously or discretely with varactor diode or PIN diode respectively [3].

Reconfigurable antennas can be classified as:

- Frequency reconfigurable
- Polarization reconfigurable
- Pattern reconfigurable
- Hybrid reconfigurable (combinations of any of the previously mentioned).

Resonant frequency for operating narrowbands is altered in frequency reconfigurable antenna. Various conditions of working of reconfigurable antenna are obtained by different switching techniques. Status of the PIN diode: ON or OFF affects the surface current path length and hence the mode of operation. Optically controlled photo conductive switches also alter the resonant frequency of patch antenna [4].

Variation in bias voltage of varactor diodes also shifts the resonant frequency of patch antenna. Varactor diodes are placed between radiating stems. Field effect transistors (FETs) are also used for reconfigurability in patch antenna [5].

2. Reconfigurable Antenna Technology

Frequency reconfigurable antennas are implemented utilizing PIN diodes, Varactor diodes, FETs and Micro Electromechanical Switches (MEMS). In this section, various patch antennas, DGS antennas and reconfigurable antennas operating in UWB have been covered. References are selected according to the applied technology and design concepts.

[6] Yan Zhang et al. presented a reconfigurable elliptical-patch wideband structure for UWB applications. Notch bands are achieved by employing switch in the structure. Shifting of position of switch results in variation of notch frequencies. Proposed antenna covers entire ultra wideband except either WiMAX 3.3/3.6 GHz or WLAN 5.15/5.825 GHz or

both.

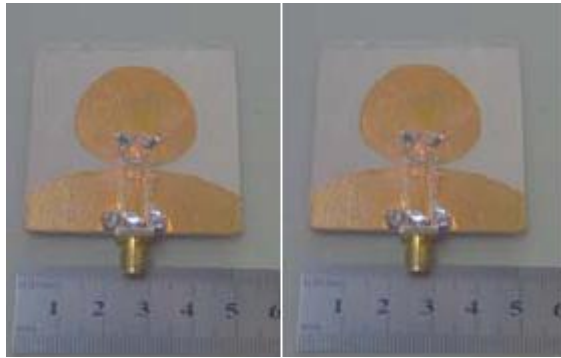

Figure 2: Reconfigurable elliptical-patch wide band Antenna [6]

[7] Syed Muzahir Abbas et al. Presented an ultra wide band (UWB) compact $28 \times 24 \times 1.524 \text{ mm}^3$ monopole antenna which is tunable from 3.55-6.8 GHz frequency range. T-shaped radiating patch is printed with 50 ohm microstrip feed to achieve impedance matching over UWB. It shows stable gain, return loss below -10 dB for entire UWB and is compact in size.

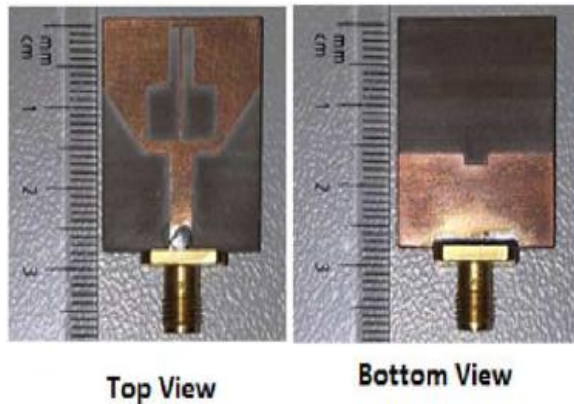

Figure 3: Ultra wideband compact monopole Antenna [7]

[8] N. Ojaroudi et al. proposed a frequency notched UWB microstrip antenna with a S-shaped slot in radiating stub and a parasitic C-pair in ground plane. Defected ground with parasitic C-shaped symmetry is used to improve fractional bandwidth (BW). This proposed structure has a dimension of $20 \times 20 \text{ sq. mm}$. which provides a good omnidirectional pattern. It has a BW of 2.9 GHz to 14.4 GHz with a notch of 5.07 GHz to 5.93 GHz. This antenna generates single notch band characteristics with a S-slot in patch.

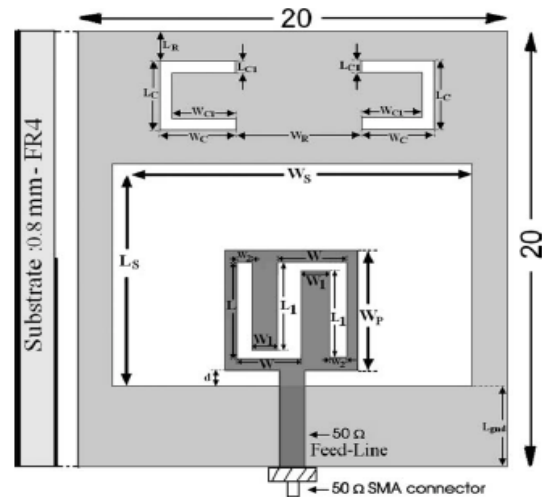

Figure 4: Frequency notched ultra wide band Antenna [8]

[9] A. Grau et al. presented a linearly polarized compact reconfigurable antenna. It is two-port structure with quartz substrate. Design is selective between dual polarization bases with MEMS which are monolithically integrated. This two-fold structure operates on 3.8 GHz with partial BW of 1.7%. MEMS can be easily integrated monolithically inside quartz substrate or PCBs, provide great isolation, less insertion loss. Radiation response is constantly below -15 dB.

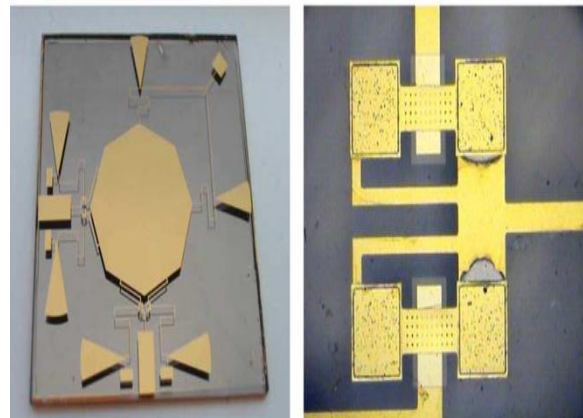

Figure 6: Reconfigurable Octagonal Isolated Orthogonal Element Antenna [9]

[10] Ayman A. R. Saad et al. presented slot-loading technique based multi-band microstrip UWB antenna. It incorporates 7-segment slot in rectangular stub. Geometrical configuration may be varied as per the required resonant frequencies within wide-bands. Applications in BW 2 GHz to 8 GHz like WLAN, WiMAX and WCDMA are covered with this structure. Author compared the results of antenna

performance with perfect conventional conducting ground and defected ground both. Fabricated DGS (defected ground structure) antenna demonstrates broad frequency range and high gain as compared to conventional ground. Size of antenna is reduced upto 26% and BW of 2-8 GHz is achieved with less than 10 db return loss.



(a)

Figure 7: (a) Slot-loading technique based multi-band antenna with conventional ground [10].



(b)

Figure 7: (b) Slot-loading technique based multi-band antenna with defected ground [10].

[11] Mohamed Mamdouh M. Ali et al. proposed a rectangular slot UWB antenna which covers narrowband applications 2.4 GHz to 2.484 GHz (Bluetooth), 1.92 GHz to 2.17 GHz (UMTS), 2.5 GHz to 2.96 GHz (WiMAX) and 3.1 GHz to 9.65 GHz (Ultra wideband). Electromagnetic interference (EMI) between 3.3 GHz to 3.9 GHz (IEEE 802.16e) and UWB is notched or rejected at 3.6 GHz by introducing a U-slot in microstrip feed. Author has also presented an equivalent circuit for proposed structure using VF (Vector Fitting) technology compatible with other simulators for time domain

circuits. A stable gain antenna with omnidirectional radiations is designed with 3.2 GHz to 4.0 GHz notch band.

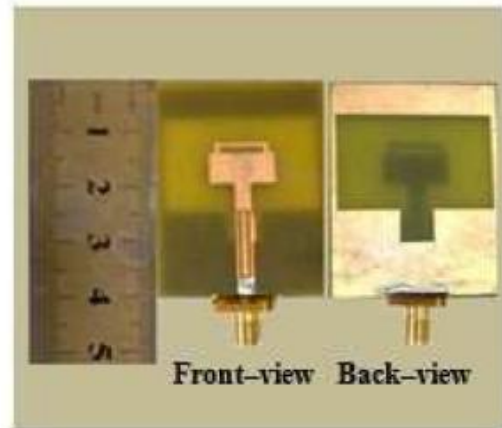

Figure 8: Rectangular slot Ultra wideband Antenna for Bluetooth/UMTS/WiMAX [11]

[12] A Nouri et al. proposed a compact defected ground antenna for WLAN and short distance communication. This antenna consists a shovel-shaped radiating patch. Interfering narrowband applications are notched in UWB with defected ground structure by detaching two squares from ground plane, lower edge of patch is made arc shaped to achieve omnidirectional radiation pattern. The dimension of the structure is 15x18 sq. mm. which provides 128% of impedance BW. This structure operates in 3.1 GHz to 14 GHz frequency range and provides band rejection from 5.13 GHz to 6.1 GHz.



Figure 9: Compact DGS Microstrip patch Antenna for WLAN [12].

[13] Z. Zakaria et al. presented a reconfigurable structure with defected ground on CPW (Coplaner Wave Guide) technology. Transmission zero is achieved at frequency 3.5 GHz and 5.5 GHz. Proposed structure which is basically a resonator produces both responses in UWB: Band pass and Band reject. FR-4 substrate is made 1.6 mm thick and

with $\epsilon_r = 4.6$ which increases the fringe fields of radiation. It is observed that transmission zeros can be increased by employing a P-I-N diode switch in resonator. Thus physical volume of structure is minimized and excellent results are achieved.



Figure 10: Reconfigurable CPW technology based resonator [13]

[14] Bharat Rochami et al. proposed a compact 22x27 sq. mm. microstrip antenna with microstrip feed. Broadband characteristics are achieved in UWB from 1.65 GHz to 10.68 GHz. Bandwidth (BW) of proposed antenna is increased by introducing two stubs in half ground plane making it a DGS (defected ground Structure). Compactness, Stable radiation pattern, return loss characteristics make it a good candidate for UWB applications.

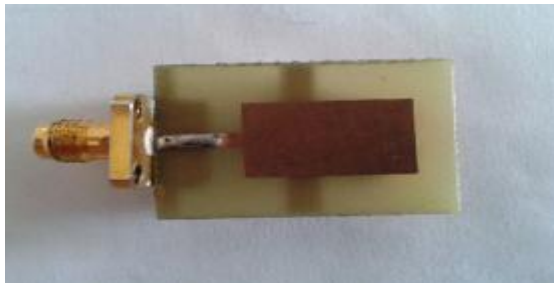

(a)

Figure 11:(a) Compact half ground (DGS) UWB Antenna (front view) [14].

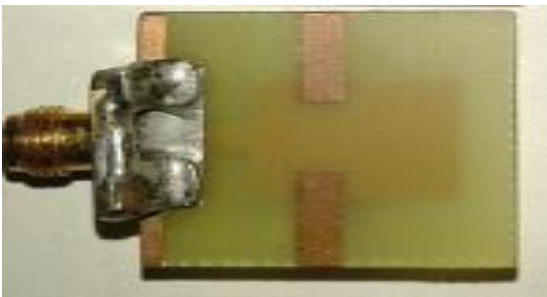

(b)

Figure 11:(a) Compact half ground (DGS) UWB Antenna (back view) [14].

[15] Nishant Kumar et al. presented a reconfigurable antenna for cognitive radio. PIN diode is used as a switching element to get frequency selectivity. This reconfigurable structure has a BW of 3 GHz to 10 GHz. Two semicircular patches are grouped to make the proposed antenna patch. Filters are inserted in feed lines to achieve frequency selectivity. It gives constant omnidirectional radiation characteristics and 70% radiation efficiency. CST software is used to simulate the structure.

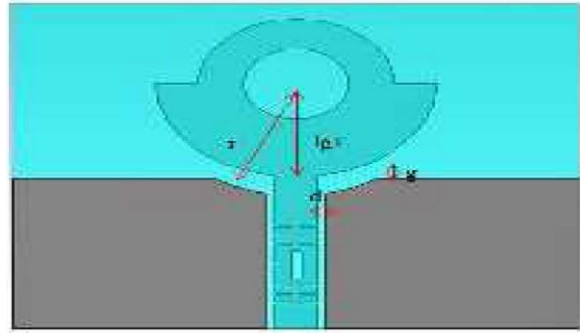

Figure 12: Frequency Reconfigurable Microstrip Antenna for Cognitive Radio [15].

[16] Wen-Chung Liu et al. proposed a defected ground monopole antenna for WLAN, WiMAX applications. It has an overall dimension of 20x30 sq. mm. with L-shaped inverted strips in pair as patch. Feed is cross shaped microstrip line. Antenna shows a good gain and radiation pattern over the operating frequencies 2.4GHz/5.2GHz/5.8GHz WLAN and 3.5GHz/5.5GHz WiMAX.

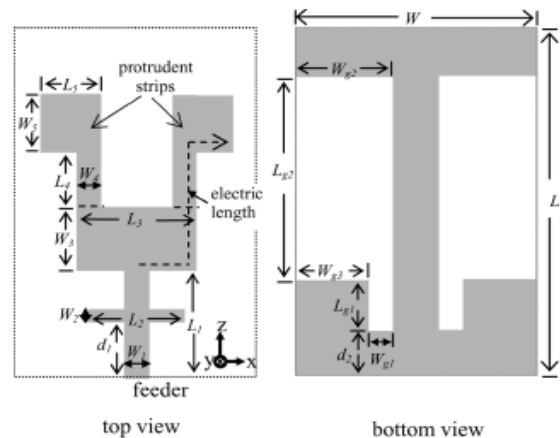

Figure 13: Inverted L-shaped pair defected ground monopole antenna for WLAN/WiMAX [16].

[17] Yingsong LI et al. proposed a 32x24 sq.mm. wide reconfigurable antenna with circular patch for UWB applications. Four MEMS are employed in the structure to make it work in either of four different

modes: UWB, Four band/Trippl notch, Tri-band/dual notch or dual band/single notch. Operation of antenna in a desired mode is controlled by On/Off status of MEMS.

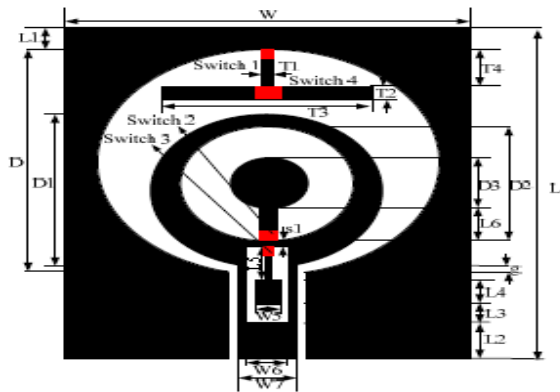

Figure 14: Circular patch Reconfigurable Antenna with micro electromechanical switch (MEMS) [17].

[18] Michele D'Amico et al. proposed a rectangular slot antenna with even elliptical traps: two and four respectively for UWB applications. Antenna shows the consistent radiation response and return loss is below -10 dB for entire ultra wideband 3.1GHz to 10.6 GHz. Positions of openings in ground and elliptical traps in patch, compactness, aspect ratio is studied through simulation.

[19] Kenny Seungwoo Ryu et al. represented an antenna to remove existing electromagnetic interference (EMI) within UWB realizing band notches in design. Dimension of the structure is 24x36 sq. mm. It is designed for single notch and dual notch using one or two strips respectively. Antenna covers the broad frequency range from 3 GHz to 12 GHz (UWB) with two rejection bands 5.15 GHz to 5.35 GHz lower WLAN and upper WLAN 5.725 GHz to 5.825 GHz in dual notch band design.

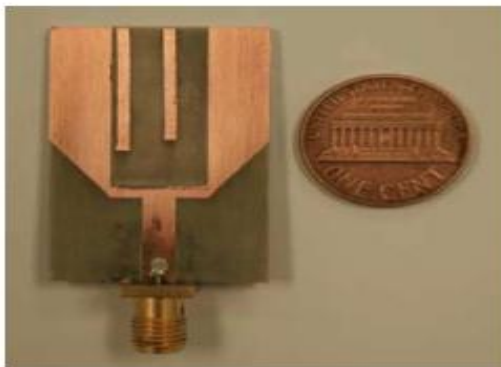

Figure 15: Microstrip dual band reject antenna for lower/upper WLAN [19].

[20] Saou-wen Su et al. proposed a compact 25x26 sq. mm. circular slot UWB antenna with single notch band at 5 GHz. Inside the circular stub a U-slot is removed to obtain band notch operation in UWB (Ultra Wideband). This design of antenna acts as a model for other single band-notch antennas. Compactness, antenna-gain, return loss, VSWR and radiation response is investigated through simulation.

[21] Yinsong Li et al. proposed a reconfigurable circular slot antenna for multi-band applications in UWB. Proposed structure can operate in three different modes: UWB, UWB with dual notch, and multi-band antenna. It has flexible design switching between various modes. Two switches are implemented on SIRs (Stepped Impedance Resonators) to design an antenna with switchable radiation responses and notch functions. Antenna operates in broad range of frequency in UWB with two notch bands at 5.5 GHz and 7 GHz.



(a)

Figure 10: (a) Reconfigurable patch Antenna with both switches ON [21].

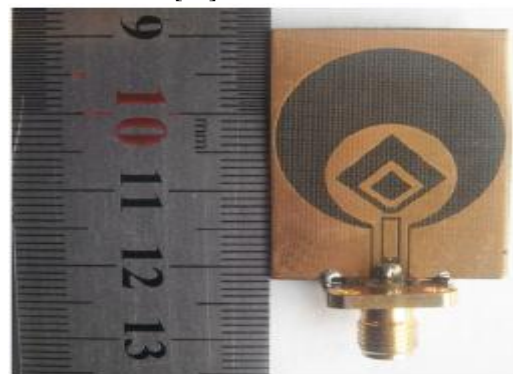

(b)

Figure 10:(b) Reconfigurable patch Antenna with both switches OFF [21].

[22] Sajad Mohammad et al. presented a 28x28x1 mm³ dual band pentagonal slot antenna with microstrip feed for MIMO applications. It is designed to operate in 2.46 GHz to 2.485 GHz WLAN and 3.1 GHz to 10.6 GHz UWB. Antenna parameters like

return loss, radiation response, VSWR, BW are investigated for different configurations of antenna.

Pros and cons of switching elements used in reconfigurable antennas:

MEMS Pros:

- Low DC power requirement
- Large BW
- Linearity
- Reduced insertion loss

Cons:

- Expensive
- Poor switching speed
- Poor reliability
- High control voltage
- Discrete tuning

PIN Diode Pros:

- Low driving voltage
- Elevated tuning speed (1-100ns)
- Power handling capability
- Low speed

Cons:

- Non-linear performance
- Discrete tuning
- High current in ON state
- Poor quality factor

Varactor diode Pros:

- Low current
- Continuous tuning

Cons:

- Non-linear characteristics
- Small dynamic range

3. CONCLUSION

According to a report by CISCO, continuous growth of 4G network and ever increasing wireless users will tend to 800% increase in wireless traffic by 2020. Ultra wideband has the BW to accommodate this huge wireless traffic efficiently. In Asia Pacific (India, China etc.) narrowband communication systems have 2.3/2.5/3.3/3.5 GHz frequency bands for WiMAX, 2.4-2.485 GHz for Bluetooth, 2.4/3.65/4.9/5/5.9 GHz frequency band for WLAN. These narrowband systems co-exist within UWB and introduce EMI (Electromagnetic Interference) restricting the use of entire UWB at any time. Thus to enhance the performance of UWB antenna reconfigurable antenna is designed. It efficiently eliminates the interference from co-existing narrowband systems and allows antenna to use a broad range of frequencies in Ultra wideband, UWB.

REFERENCES

- [1] Pramod Singh and Rekha Aggarwal "Design of Ultra Wideband Antenna with Triple Band Notch for Minimum EMI", *Microwave and Optical Technology Letters*, Vol. 58, No. 7, pp. 1521-1525, July 2016.
- [2] Ashwini K. Arya, M.V. Kartikeyan and A. Patnaik, "Defective Ground Structure in the Perspective of Microstrip Antenna: A Review", *FREQUENZ Journal of RF-Engineering and Telecommunications*, Vol. 64, Issue 5-6, pp. 79-84, Jun. 2010.
- [3] A. A. Kalteh, G. R. Dadashzadeh, M. Naser-Moghadasi and B. S. Virdee, "Ultra-Wideband Circular Slot Antenna with Reconfigurable Notch Band Function", *IET microwaves, Antennas & Propagation*, Vol. 6, Issue 1, pp. 108-112, 2012.
- [4] Nasrin Tasouji, Javad Nourinia, Changiz Ghobadi, and Farzad Tofigh, "A Novel Printed UWB Slot Antenna with Reconfigurable Band-Notched Characteristics", *IEEE Antennas and Wireless Propagation Letters*, Vol. 12, pp. 922-925, 2013.
- [5] Si-Yan Chen and Qing-Xin Chu, "A Reconfigurable Dual Notched-Band UWB Antenna", *IEEE 4th Asia-Pacific Conference on Antennas and Propagation*, pp. 103-104, 2015.
- [6] Yan Zhang, Qing-lin Shi, Shan-Shan Lin, Shan-wei Lü, "A Novel Reconfigurable Notched-Band UWB Antenna", *IEEE International Symposium on Antennas, Propagation & EM Theory*, pp. 369-372, 2012.
- [7] Syed Muzahir Abbas, Yogesh Ranga, Anand K. Verma, and Karu P. Esselle, "A Simple Ultra Wideband Printed Monopole Antenna With High Band Rejection and Wide Radiation Patterns", *IEEE Transactions On Antennas And Propagation*, Vol. 62, No. 9, pp. 4816-4820, SEPTEMBER 2014.
- [8] N. Ojaroudi, M. Ojaroudi, and H. Ebarhimian, "Band-Notched UWB Microstrip Slot Antenna With Enhanced Bandwidth By Using A Pair Of C-Shaped Slots", *Microwave And Optical Technology Letters / Vol. 54, No. 2*, pp.515-518, February 2012.
- [9] A. Grau, J. Romeu, M. J. Lee, S. Blanch, L. Jofre and F. De Flaviis "A Dual-Linearly-polarized MEMS-reconfigurable Antenna for Narrowband MIMO Communication Systems", *IEEE Antennas and Wireless Propagation Letters*, Vol. 58, no. 1, pp. 4-17, 2010.
- [10] Ayman A. R. Saad, Elsayed E. M. Khaled, and Deena A. Salem, "Wideband Slotted Planar Antenna with Defected Ground Structure", *PIERS Proceedings, Suzhou, China*, pp. 1092-1097, September 12-16, 2011.
- [11] Mohamed Mamdouh M. Ali, Ayman Ayd R. Saad, and Elsayed Esam M. Khaled, "A Microstrip-fed Printed Slot Antenna for 3G/Bluetooth/WiMAX and UWB Applications with 3.6GHz Band Rejection", *PIERS Proceedings, Stockholm, Sweden*, pp. 588-592, Aug. 12-15, 2013.
- [12] A. Nouri and G. R. Dadashzadeh, "A Compact UWB Band-Notched Printed Monopole Antenna With Defected Ground Structure", *IEEE Antennas And Wireless Propagation Letters*, Vol. 10, pp. 1178-1181, 2011.

- [13] Z. Zakaria, N. A .Shairi, R. Sulaiman and W. Y. Sam, "Design of Reconfigurable Defected Ground Structure (DGS) for UWB Application", IEEE Asia-Pacific Conference on Applied Electromagnetics (APACE 2012), Melaka, Malaysia, pp.195-198, December 11 - 13, 2012.
- [14] Bharat Rochani, Rajesh Kumar Raj, Sanjay Gurjar and M. SantoshKumar Singh," Microstrip Patch Antenna with Defected Ground Plane for UWB Applications", Springer India, pp. 293-302, 2015.
- [15] Nishant Kumar, P Ananda Raju, Santanu Kumar Behera, "Frequency Reconfigurable Microstrip Antenna", IEEE International Conference on Communications and Signal Processing (ICCCSP), pp. 370-373, 2015.
- [16] Wen-Chung Liu, *Senior Member, IEEE*, Chao-Ming Wu, and Yang Dai," Design of Triple Frequency Microstrip-Fed Monopole Antenna Using Defected Ground Structure", IEEE Transactions on Antennas And Propagation, Vol. 59, No. 7, pp. 2457-2463, July 2011.
- [17] Yingsong LI, Wen xing LI, Si Li, Tao Jiang," Miniaturization reconfigurable wide slot antenna for multi-mode wireless communication applications", IEEE Asia-Pacific Conference on Antennas and Propagation, Singapore, August 27-29, 2012.
- [18] Michele D'Amico, Fabio Mirko Fasolo," Multi-Trap CPW-Fed Wide Slot Antenna for UWB Applications", 6th European Conference on Antennas and Propagation (EUCAP), pp. 1860-1864.
- [19] Kenny Seungwoo Ryu, *Student Member, IEEE*, and Ahmed A. Kishk, *Fellow, IEEE*, "UWB Antenna With Single Or Dual Band-Notches For Lower WLAN Band And Upper WLAN Band", IEEE Transactions On Antennas And Propagation, Vol. 57, No. 12, pp.3942-3950, December 2009.
- [20] Saou-Wen Su, Kin-Lu Wong, and Fa-Shian Chang, "Compact Printed Ultra-Wideband Slot Antenna With A Band notched Operation", Microwave And Optical Technology Letters / Vol. 45, No. 2, pp.128-130, April 20, 2005.
- [21] Yingsong Li, Wenxing Li, and Qiubo Ye,"A Reconfigurable Wide Slot Antenna Integrated With Sirs For UWB/Multiband Communication Applications", Microwave And Optical Technology Letters / Vol. 55, No. 1,pp.52-55, January 2013.
- [22] Sajad Mohammad, ali nezhad, Hamid Reza Hassani, and Ali Foudazi," A Dual-Band WLAN/UWB Printed Wide Slot Antenna For MIMO/ Diversity Applications", Microwave And Optical Technology Letters / Vol. 55, No. 3, pp.461-465, March 2013.
- [23] Cheol Yoon, Won-Jong Lee, Woo-SU Kim, Hwa-Choon Lee and Hyo-Dal Park "Copact Band-Notched Ultra-Wideband printed Antenna using Inverted L-Slit", Microwave and Optical Technology Letters, Vol. 54, No. 1, pp. 143-144, January 2012.
- [24] Wen Jiang and Wenquan Che, "A Novel UWB Antenna with Dual Notched Bands for WiMAX and WLAN Applications", IEEE Antennas and Wireless Propagation Letters, Vol. 12, pp. 293-296, 2012.
- [25] Mohammad Naser-Moghadasi, Mohammad Reza Haraty, Seyed Majid Seyed Momeni and Bal S. Virdee "Novel Compact UWB Antenna with Reconfigurable Dual-Band Notches using PIN Diodes Switches Actuated without $\lambda_g/4$ DC Bias Line", Microwave and Optical Technology Letters, Vol. 54, No. 10, pp. 2392-2397, October 2012.
- [26] A. Zohur, H. Mopidevi, D. Rodrigo, M. Unlu, L. Jofre and B.A. Cetiner "RF MEMS Reconfigurable Two Band Antenna", IEEE Antennas and Wireless Propagation Letters, Vol. 12, pp. 72-75, 2013.
- [27] R. Azim, A.T. Mobashsher and M.T. Islam, "UWB Antenna with Notched Band at 5.5 GHz", IEEE Electronics Letters, Vol. 49, Issue 15, pp. 922-924, July 2013.
- [28] Uma Shankar Modani and Anubhav Kanwaria, "Frequency Reconfigurable Multiband Microstrip Patch Antenna for Various Wireless Services", International Conference on Advanced Research in Engineering and Technology (ICARET), Vol. 2, pp. 496-500, 2013.