

# Design & Analysis of Crankshaft by Forged Steel & Composite Material

M.GuruBramhananda Reddy<sup>#1</sup>, Chanduri Rajendar Prasad<sup>#2</sup>, M.Uday Kiran Reddy<sup>#3</sup>  
L. Naveen Kumar<sup>#4</sup>

<sup>#1</sup>Asst. Professor, Mechanical Eng Dept., Lords Institute of Engg. & Tech, Hyd (India)

<sup>#2</sup>Asst. Professor, Mechanical Eng Dept., Lords Institute of Engg. & Tech, Hyd (India)

<sup>#3</sup>B.tech Students, Mechanical Eng Dept., Lords Institute of Engg. & Tech, Hyd (India)

**Abstract:** Crankshaft is a standout amongst the most imperative moving parts in internal combustion engine. Crankshaft is an extensive segment with a perplexing (complex) geometry in the engine, which changes over the reciprocating displacement of the piston into a rotating movement. In this paper a static simulation is led on a crankshaft from a single cylinder 4-stroke diesel engine.

A three dimensional model of diesel engine crankshaft is made utilizing Pro-E. Finite element analysis (FEA) is performed to get the variety of stress magnitude at basic areas of crankshaft. Reproduction sources of info are taken from the engine specification chart. The static analysis is done utilizing FEA Software ANSYS which brought about the heap range connected to crank pin bearing. This load is applied to the FE model in ANSYS, and boundary conditions are applied by the engine mounting conditions.

The analysis is accomplished for finding critical location in crankshaft. Stress variation over the engine cycle and the effect of torsion and bending load in the analysis are investigated. Von-Mises stress is calculated using FEA software ANSYS.

The composite materials have high quality and solidness so that these are utilized as a part of different Engineering applications. Every one of the exhibitions will complete with the assistance of Ansys software.

**Keywords**—Steel, compositematerials, FEA Analysis, IC engine, TDC, BDC.

## I. INTRODUCTION

Crankshaft is an extensive segment with a perplexing (complex) geometry in the engine, which changes over the reciprocating displacement of the piston into a rotating movement with a four link mechanism. Since the crankshaft encounters countless cycles amid its service life, fatigue performance and toughness of this part must be considered in the design procedure. design improvements have dependably been an imperative issue in the crankshaft creation industry, so as to fabricate a more affordable component with the base weight conceivable and appropriate fatigue strength and other useful prerequisites. These enhancements result in lighter and smaller engine with better fuel efficiency and higher power output.

## II. FUNCTION

The crankshaft, connecting rod, and piston constitute a four bar slider-crank mechanism, which changes over the sliding movement of the cylinder (slider in the instrument) to a revolving movement. Since the

revolution output is more down to earth and relevant for contribution to different gadgets, the idea outline of an engine is that the output would be turn. In addition, the direct removal of an engine is not smooth, as the uprooting is brought about by the burning of gas in the combustion chamber. Hence, the removal has sudden shocks and utilizing this contribution for another gadget may make harm it.

## A. STRESS ON CRANKSHAFTS

The shaft is subjected to different forces however for the most part should be broke down in two positions. Firstly, disappointment may happen at the position of most extreme twisting; this might be at the focal point of the crank or at either end. In such a condition the disappointment is because of bowing and the weight in the chamber is maximal. Second, the wrench may flop because of curving, so the interfacing bar should be checked for shear at the position of maximal bending. The weight at this position is the maximal weight, yet just a small amount of maximal weight. A crankshaft contains at least two halfway found coaxial barrel shaped diaries and at least one balance round and cylindrical crank pin journals. The two-plane V8 crankshaft has five main journals and four rod journals, each spaced 90°.

Piston Stroke The distance the axis of the crank throws from the axis of the crankshaft determines the piston stroke measurement, and thus engine displacement. A common way to increase the low-speed torque of an engine is to increase the stroke, sometimes known as "shaft-stroking." This also increases the reciprocating vibration, however, limiting the high speed capability of the engine. In compensation, it improves the low speed operation of the engine, as the longer intake stroke through smaller valve(s) results in greater turbulence and mixing of the intake charge. Most modern high speed production engines are classified as "over square" or short-stroke, wherein the stroke is less than the diameter of the cylinder bore.

Table 1: specification of crank shaft

Physical parameters	Values
Crankpin diameter (mm)	20
Crankpin axial length (mm) 0	24
Diameter of shaft (mm)	25
Crank cheek thickness (mm)	24
Web thickness (mm)	18
Web width (mm)	106

**B. FORCES IMPOSED ON A CRANKSHAFT**

The obvious source of forces applied to a crankshaft is the product of combustion chamber weight following up on the highest point of the cylinder. Elite, ordinarily suctioned Spark-start (SI) engines can have combustion in the 100-bar neighbourhood (1450 psi), while contemporary superior Compression-Ignition (CI) motors can see burning weights in abundance of 200 bar (2900 psi). A weight of 100 bar following up on a 4.00 inch width cylinder will create compel of 18,221 pounds. A weight of 200 bar following up on a 4.00 inch distance across cylinder delivers compel of 36,442 pounds. That level of compel applied onto a crankshaft pole diary produces generous bowing and torsional minutes and the subsequent pliable, compressive and shear stresses.

Nonetheless, there is another significant wellspring of strengths forced on a crankshaft, to be specific Piston Acceleration. The joined weight of the cylinder, ring bundle, wristpin, retainers, the conrod little end and a little measure of oil are by and large persistently quickened from rest to high speed and back to rest twice every crankshaft insurgency. Since the compel it takes to quicken a protest is corresponding to the heaviness of the question times the speeding up (the length of the mass of the protest is steady), a considerable lot of the critical strengths applied on those responding segments, and in addition on the conrod shaft and enormous end, crankshaft, crankshaft, heading, and motor square are specifically identified with piston increasing speed. These increasing speed strengths consolidate in complex approaches to create essential and optional shaking powers and also essential and auxiliary shaking minutes. The mixes of powers and minutes change with the chamber game plan (inline, restricted, 60°V, 90°V, 120°V, and so forth.) and with the crankpin detachment (60°/90°/120°/180°, and so forth.). They should, to the most extreme degree conceivable, be neutralized by the execution of the crankshaft stabilizers. A significant number of the basic engine game plans take into account finish adjusting of essential and optional strengths and minutes. Cases are inline six chamber motors with 120° crank pin dividing and 90° V8 engines with ordinary 90° crank pin separating.

**III. MODELLING:**

Initially 2D drawings were created using sketcher toolbar; tools in profile tool bar such As line, circle, rectangle, points, reference lines etc ... and sketch references like grid, vertex, and dimensions are used.

**Modules of PRO/E**

- 1 .Sketcher
2. Part Design
3. Assembly
4. Drawing

The drawings created by using completely constrained the tool in constraint tool bar like constraint and auto constraint. Then 2D drawings were converted into 3D using sketch based features tools such as extrude, swept blend, blend. 3D objects are modified as required using engineering feature tool bar, tools such as edge fillet, chamfer are used. So in this project we are going to compare the design between Forged Steel and composite material. The composite materials have high strength and durability so that these are used in various Engineering applications. All the performances will carry out with the help of Ansys software.

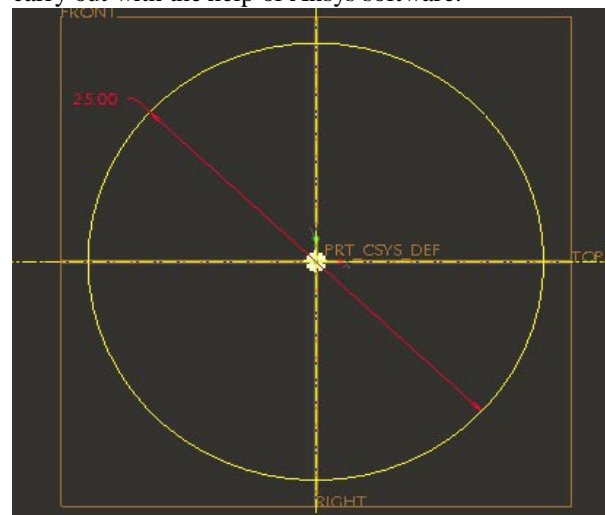

Fig. 12D Drawings

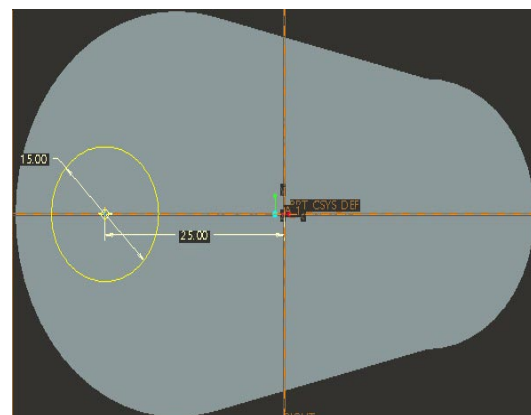

Fig. 22D Drawings

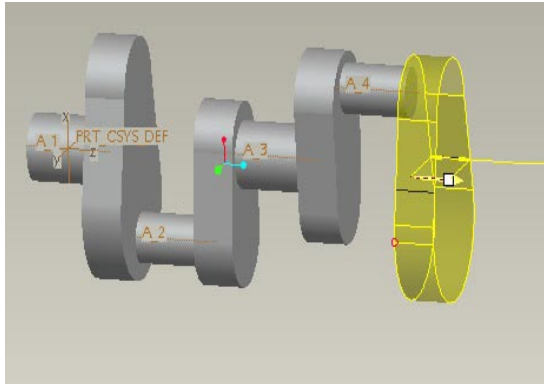

Fig. 3 3D final Model of Crankshaft

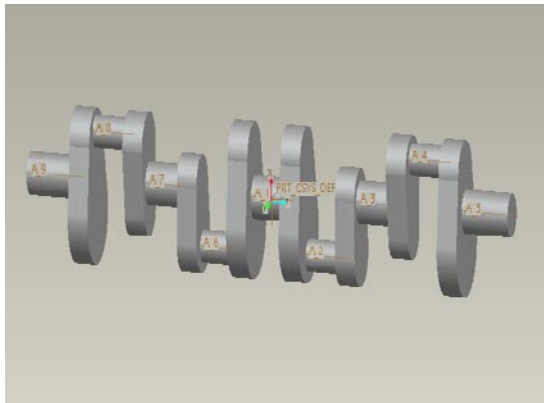

Fig. 4 Solid Model of Crankshaft

#### IV. ANSYS

ANSYS is the standard FEA teaching tool within the Mechanical Engineering Department at many universities and colleges. ANSYS is also used in Civil and Electrical Engineering, as well as the Physics and Chemistry departments.

ANSYS gives a financially savvy approach to investigate the execution of items or procedures in a virtual domain. This sort of item improvement is named virtual prototyping.

##### A. MODAL ANALYSIS

A modal analysis is commonly used to decide the vibration qualities (regular frequencies and mode shapes) of a structure or a machine part while it is being composed. It can likewise fill in as a beginning stage for another, more point by point, dynamic examination, for example, a harmonic reaction or full transient element investigation. Modal analyses, while being one of the most basic dynamic analysis types available in ANSYS, can also be more computationally time consuming than a typical static analysis. A reduced solver, utilizing automatically or manually selected master degrees of freedom is used to drastically reduce the problem size.

##### Material Type: - Forged Steel

Designation: - 42CrMo4

Yield strength (MPa):- 680

Ultimate tensile strength (MPa):- 850

Elongation (%):-13

Poisson ratio:-0.3

Young's Modulus:- $210E^3$  MPA

Density:- $7.9 \text{ g/cm}^3$

**Material Type: - Composite material**

Designation:- Epoxy

Poisson ratio:- 0.34

Young's Modulus:-140

Density:-1.6

Yield strength (MPa):-1900

Applied Pressure = 100 Bar

Avg. Speed (N) = 1800 rpm, so angular velocity =

$\omega = 2\pi N/60 = 188 \text{ rad/s}$

#### Results on forged steel:

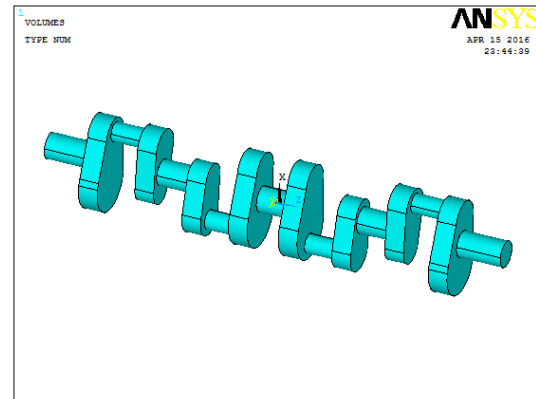

Fig 5: IGES Model of crankshaft

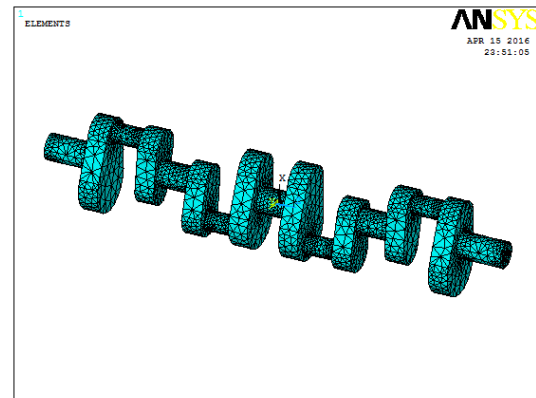

Fig. 6 Meshed Model

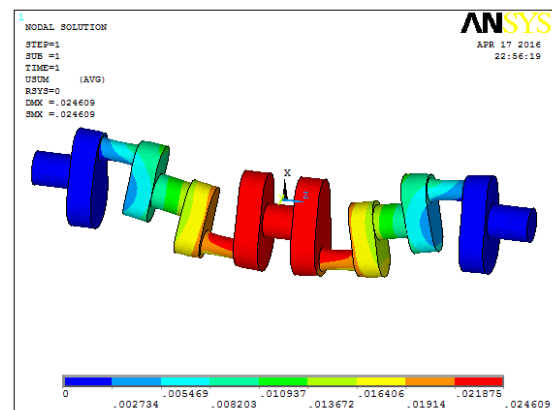

Fig. 7 Displacement Vector Sum

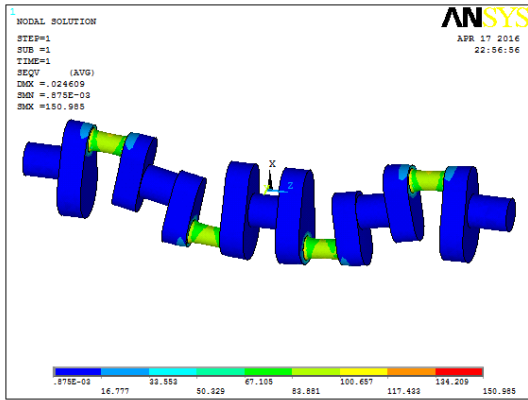

Fig 8 Von Mises Stress

**Results on composite material:**

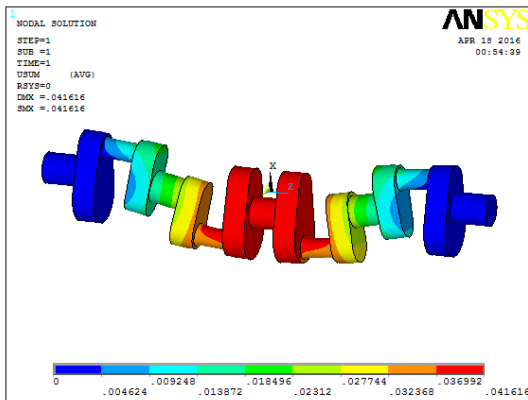

Fig 9 Displacement Vector Sum

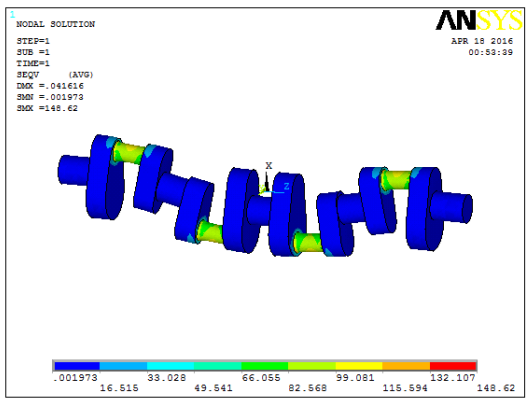

Fig. 10 Displacement vector sum

Analysis option → reduced → No of modes to extract = 10, No. of modes to expand = 10 → ok  
 Enter Frequency range = 0 to 1000 Hz, no of modes to print = 10 → ok  
 Master DOF's → program selected → 10 → ok  
 Define loads → apply → structural → displacement → on area → all DOF → 0 → ok  
 Apply → pressure → on areas → 100 → ok  
 Inertia → angular velocity → global → in X direction → 188 → ok  
 Solve → current LS → ok  
 General postproc → Read results → by pick → select first step of frequency → Read → Nodal sol → displacement vector sum → ok  
 Again read results → by pick then plot results. These steps are used until the last set up of frequencies.

**MATERIAL: FORGED STEEL**

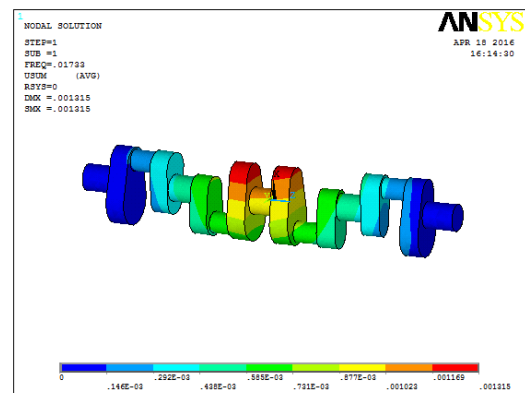

fig 10 First vibration mode of crankshaft

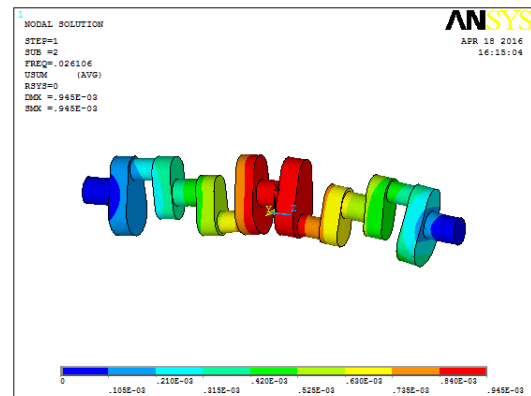

Fig11 Second vibration mode of crankshaft

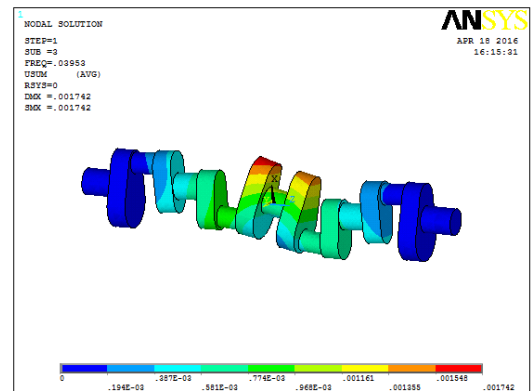

fig12 Third vibration mode of crankshaft

**MODEL ANALYSIS:**

File → import → IGES → browse file → ok  
 Preferences → structural → ok  
 Preprocessor → element type → Add/edit/delete → Add → solid → 20node186 → ok  
 Material prop → material model → structural → linear → elastic → isotropic → EX = 210e<sup>3</sup>, PRXY = 0.3  
 Density = 7.9  
 Meshing → mesh tools → smart size on → select size 3 → mesh → select volume by mouse → ok  
 Solution → Analysis type → new analysis → Model → ok

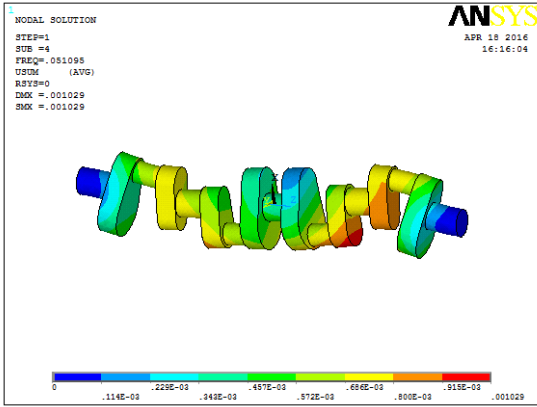

fig13 Fourth vibration mode of crankshaft

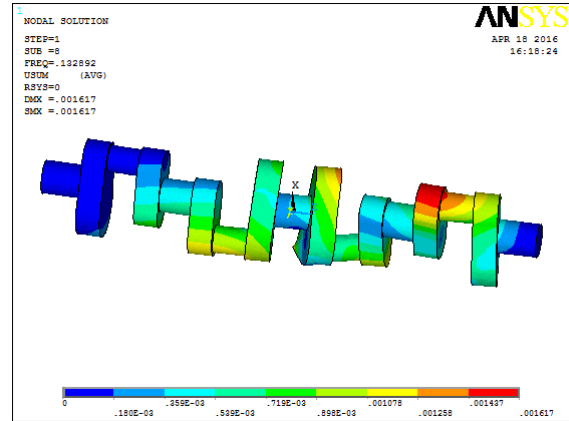

fig17 Eighth vibration mode of crankshaft

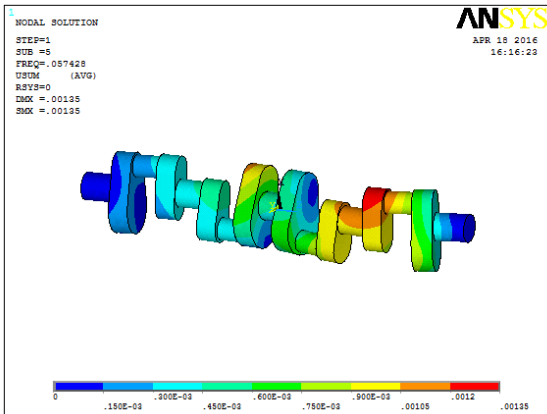

fig14 Fifth vibration mode of crankshaft

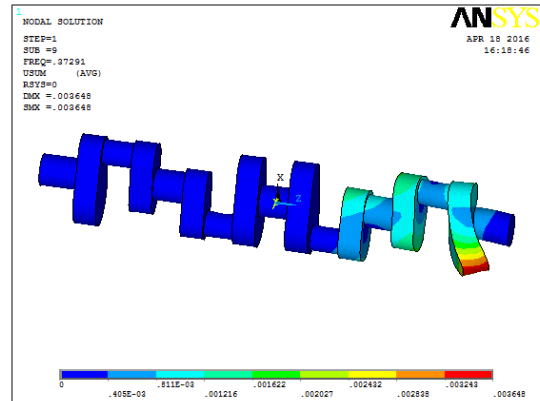

fig18 Ninth vibration mode of crankshaft

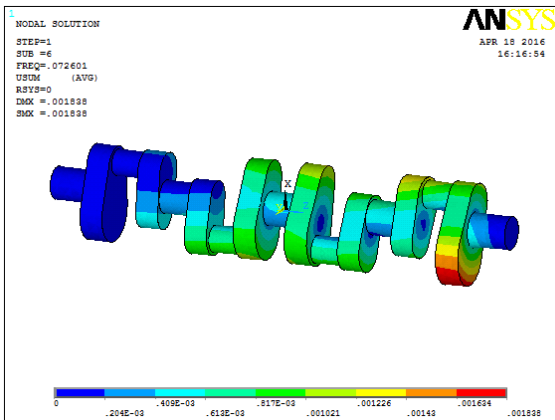

fig15 Sixth vibration mode of crankshaft

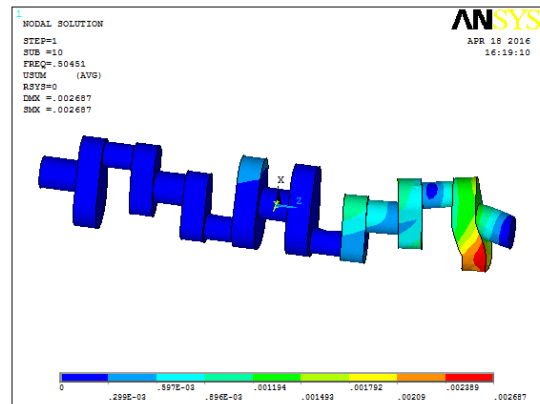

fig19 Tenth vibration mode of crankshaft

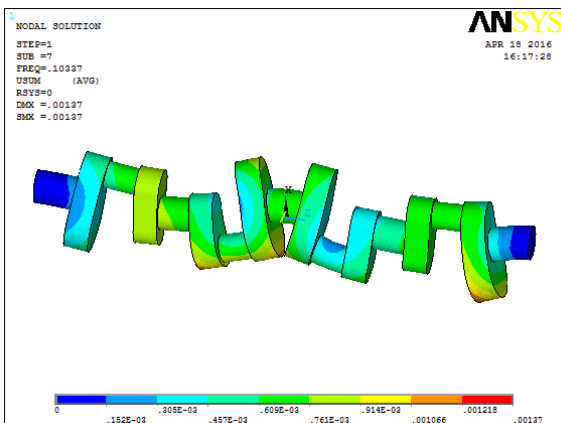

fig16 Seventh vibration mode of crankshaft

**MATERIAL: COMPOSITE EPOXY**

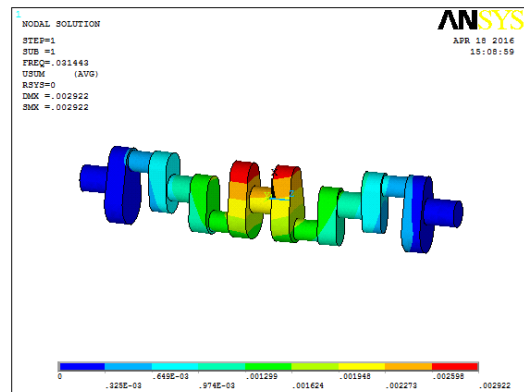

fig20 1<sup>st</sup> vibration mode of crankshaft

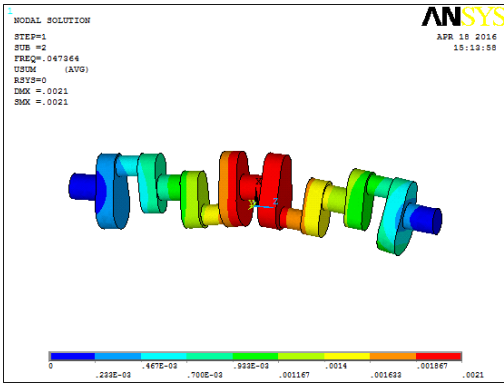

fig21 Second vibration mode of crankshaft

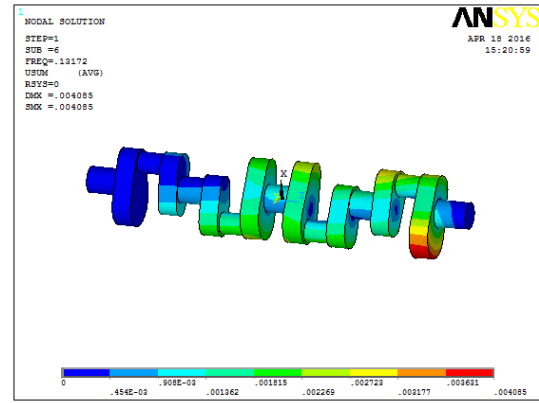

fig25 6<sup>th</sup> vibration mode of crankshaft

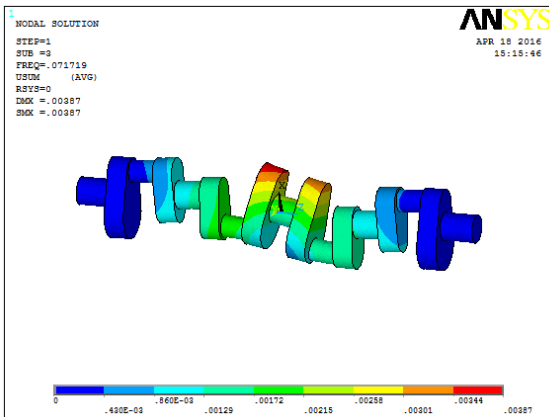

fig22 3<sup>rd</sup> vibration mode of crankshaft

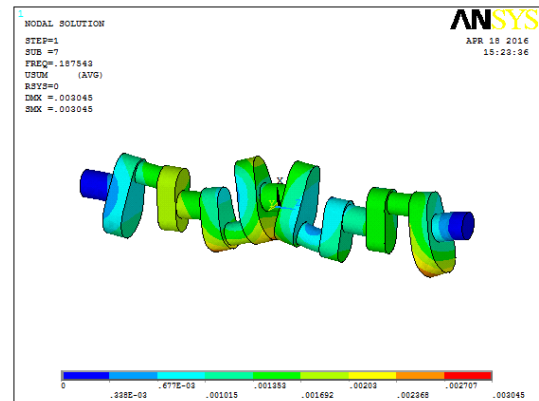

fig26 7<sup>th</sup> vibration mode of crankshaft

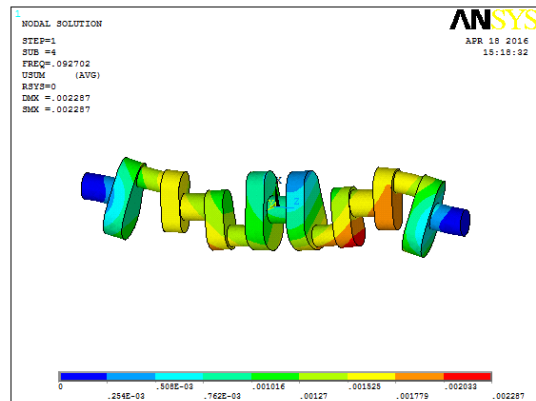

fig23 4<sup>th</sup> vibration mode of crankshaft

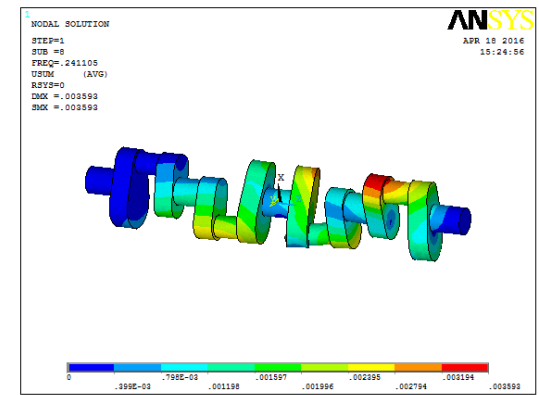

fig27 8<sup>th</sup> vibration mode of crankshaft

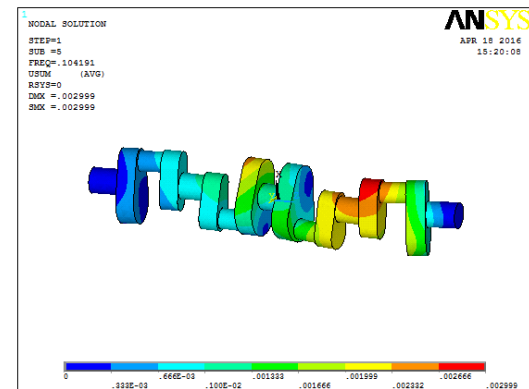

fig24 5<sup>th</sup> vibration mode of crankshaft

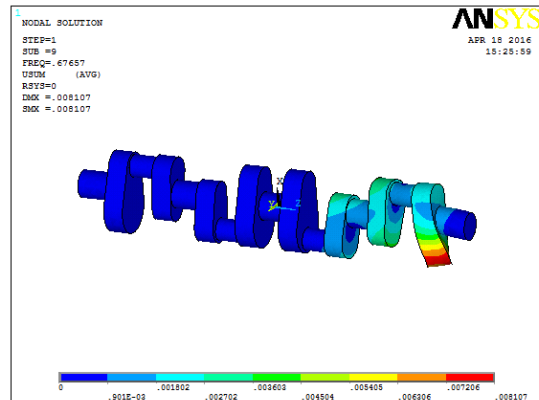

fig28 9<sup>th</sup> vibration mode of crankshaft

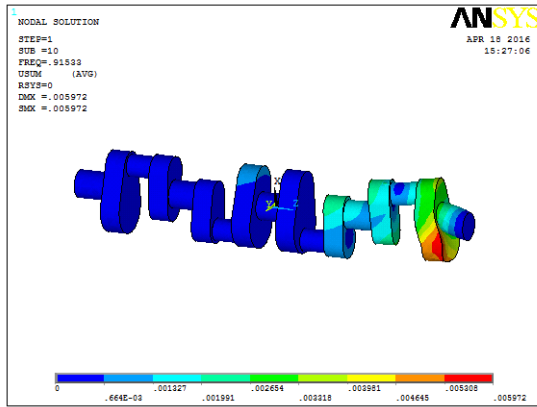

fig 29 10<sup>th</sup> vibration mode of crankshaft

### V. RESULTS AND DISCUSSIONS

The structural analysis calculations on both materials are given below:

The Frequencies Model Analysis of Crankshaft results are given below:

Properties	Forged Steel	Composite Material
Displacement vector Sum (m)	0.0246	0.0416
Von Mises Stress (MPa)	150	146

Properties (Hz)	Forged Steel	Composite Material
1 <sup>st</sup> frequency mode	0.01733	0.031443
2 <sup>nd</sup> frequency mode	0.026106	0.047364
3 <sup>rd</sup> frequency mode	0.03953	0.071719
4 <sup>th</sup> frequency mode	0.051095	0.092702
5 <sup>th</sup> frequency mode	0.057428	0.104191
6 <sup>th</sup> frequency mode	0.072601	0.13172
7 <sup>th</sup> frequency mode	0.10337	0.187543
8 <sup>th</sup> frequency mode	0.132892	0.241105
9 <sup>th</sup> frequency mode	0.37291	0.67657
10 <sup>th</sup> frequency mode	0.50451	0.91533

### VI. CONCLUSIONS

In this paper, the crankshaft model was created by Pro/ENGINEER software. Then the created model was imported to ANSYS software. After structural analysis of crankshaft the maximum stress value on **forged steel** is 150 MPa and on composite material is 146 MPa. So the composite materials have better performance than forged steel. But the manufacturing cost of composites is higher than the forged steel so due to the low cost of forged material, it's almost used for crankshaft.

### REFERENCES

- [1]. Altan, T., Oh, S., and Gegel, H. L., 1983, "Metal Forming Fundamentals and Applications," American Society for Metals, Metal Park, OH, USA.
- [2]. Ando, S., Yamane, S., Doi, Y., Sakurai, H., and Meguro, H., 1992, "Method for Forming Crankshaft," US Patent No. 5115663, United States Patent.
- [3]. Baxter, W. J., 1993, "Detection of Fatigue Damage in Crankshafts with the Gel Electrode," SAE Technical Paper No. 930409, Society of Automotive Engineers, Warrendale, PA, USA.
- [4]. Borges, A. C., Oliveira, L. C., and Neto, P. S., 2002, "Stress Distribution in a Crankshaft Crank Using a Geometrically Restricted Finite Element Model," SAE Technical Paper No. 2002-01-2183, Society of Automotive Engineers, Warrendale, PA, USA.
- [5]. Burrell, N. K., 1985, "Controlled Shot Peening of Automotive Components," SAE Technical Paper No. 850365, Society of Automotive Engineers, Warrendale, PA, USA.
- [6]. Chien, W. Y., Pan, J., Close, D., and Ho, S., 2005, "Fatigue Analysis of Crankshaft Sections Under Bending with Consideration of Residual Stresses," International Journal of Fatigue, Vol. 27, pp. 1-19.
- [7]. Fergusen, C. R., 1986, "Internal Combustion Engines, Applied Thermodynamics," John Wiley and Sons, Inc., New York, NY, USA.
- [8]. Guagliano, M., Terranova, A., and Vergani, L., 1993, "Theoretical and Experimental Study of the Stress Concentration Factor in Diesel Engine Crankshafts," Journal of Mechanical Design, Vol. 115, pp. 47-52.
- [9]. Halderman J. D. and Mitchell, C. D., 2001, "Automotive Engines," 1st edition, Prentice Hall, Inc., Upper Saddle River, NJ, USA.
- [10]. Henry, J., Topolsky, J., and Abramczuk, M., 1992, "Crankshaft Durability Prediction – A New 3-D Approach," SAE
- [11] Finite Element Analysis and Optimization of Crank Shaft of Briquette Machine by Ramkumar R, Lenin V R, Krishnaraju A, Senthilkumar M, International Journal of Engineering Trends and Technology (IJETT) – Volume 21 Number 1 – March 2015
- [12]. Failure Analysis of Crankshaft by Finite Element Method-A Review by Ms. Shweta Ambadas Naik, International Journal of Engineering Trends and Technology (IJETT) – Volume 19 Number 5 – Jan 2015