

A Review on Smart Bulb & Proposed a Real Time Vision Based Smart Bulb using Image Processing

Dashrath Mahto^{#1}, Sreeja Nair^{*2}

[#]M. Tech. Scholar Computer Science & Engineering, Oriental Institute of Science & Technology, Bhopal, India
^{*}Associate Professor Computer Science & Engineering, Oriental Institute of Science & Technology, Bhopal, India

Abstract— In recent years, light bulb is getting smarter because of its smart behavior. It means that it can be controlled via smartphone through wireless connection and even you may control it when you are not at your home. Now a day's market place has been occupied with the smart bulbs replacing CFLs and traditional LED. It is totally differ from the traditional bulb even much more expensive as compare to the traditional one. Smart bulb offers remote control feature along with schedule timer, it means that you have a smartphone as a remote and you can also set timer to turn off or on these bulbs. Even it can be control through GPS installed in your smartphone. It means that when you are bit far away from your home and you forget to turn off your bulbs then you can turn off it, your bulb is almost another smartphone that is why it is expensive as compare to the traditional bulb. Now it's time to replace this smart bulb from new era with much smarter bulb which is going to be proposed i.e. Real Time Vision Based Smart Bulb Using Image Processing. It will work like a human vision, a bulb which does not require any manual control, it will be operated automatically. It means that it will automatically sense when it should be off and on. When no one is present in the room for 20 minutes, it will automatically off and when you come, it will automatically on. One more feature is very effective in it, is when you present in the room and there is no movement for one hour then it will automatically off, because it is practically demonstrated that no one can be totally stable for one hour when he is not sleeping or when he is conscious. He must have any kind of movement if he is conscious. He must be slept if he is not responding for one hour. It will consider that you are sleeping and bulb should be turned off. Even you may turn off or on this feature as per your desire. Definitely it will save your electricity when you are not in your home or even you are at home. It is intelligent enough to control the system by itself. And no smartphone or any remote control

device is required. It will be the most intelligent light bulb till now.

Keywords— Smart Bulb, Image Processing, CFL, LED, MATLAB, GPS etc.

1. INTRODUCTION

1.1 Introduction of Present System

Today's light bulbs control through switches, it requires man power to turn off or on. Actually LED was introduced to replace CFLs because of power consumption. LED requires much lesser power as compare to CFLs. But later this LED technique gets enhanced with wireless control system. It means that there will be a Wi-Fi device embedded in the bulb and it can be connected to your smartphone via application and by the help of this you may control your bulbs as per your comfort. Even you may control your bulb when you will not be in your house; it will be controlled through GPS which is installed in the bulb as well as in your smartphone.



Fig. 1.1.1 Smart LED Bulb

Present smart LED can also emit light in various colors, it has color effect features. There are so many kinds of smart LED bulbs available in market such as Philips Hue Connected Bulb, Philips Hue White, C by GE Starter Pack, Cree Connected LED Bulb, GE Link Connected LED, LIFX Color 1000, Philips Hue Wireless Dimming Kit, TikTeck Smart LED Light Bulb, MiPow Playbulb Rainbow, Stack Down light Starter Kit and many more. Few of them can sense low light and able to turn it brighter in that case and few of them can emit multiple colors of light and rest all are able to connect to smartphone for remote control.

1.2 Introduction of Proposed System

1.2.1 Smart Light Bulb:

To replace present system, we have new promising concept which is intelligent enough for real time decision making. We proposed a new promising system which will be able to monitor real time activity. It is slightly differ from the present system, here we are not going to control it through your smartphone and we are going to develop a system which will be intelligent enough to take decisions on real time with practical sense i.e. when it should be turned off or on. Suppose you are working on living room and after some time you go to your bed room to sleep, but you forgot to turned off your bulb, in this case if we are using a traditional bulb then it will remain on until you turned it off and if we are using smart LED then it will also remain on because you will also have to turn off it manually through your smartphone, but if we talk about our system then it will check if you are not coming to your living room till 30 minutes then it will off light automatically. No need to turn it off manually, even when you come back to your living room it will on your bulb automatically. One more thing which is not possible for traditional bulb as well as present smart LED is that when you are working in your living room and after a while you got sleep there while working then if we talk about traditional system, the light bulb will remain on till your effort will not come, it is as similar with present smart LED but our system has a sense if you are stable for 1 hour or no movement with your body, definitely you are sleeping as well, because it is practically demonstrated that if someone has no movement till 1 hour then definitely he is not conscious. In this case our system will turn off the switch automatically and it will turn on when you show your palm as signal. It is totally incredible to observe and it will make your lifestyle easier.

2. LITERATURE SURVEY

2.1 Review on existing systems:

There are so many papers proposed for smart LED but all these systems lacking somewhere. Few of them are manually controlled and few of them can control the light bulb automatically but why they are not so much efficient let it to be more precise.

Smart LED lighting system implementation using Human tracking US/IR sensor proposed by Daeho Kim¹, Junghoon Lee¹ and Yeongmin Jang², Jaesang Cha¹*in

978-1-4577-1268-5/11/\$26.00 ©2011
IEEE. [1]

This paper was proposed in 2011 which was based on ultrasonic sensor (US) and infrared sensor (IR) to track human and by tracking human it operates the bulb automatically but these sensors are not enough intelligent to recognize human, these sensors are also very expensive to embedded. That is why there is no practical model proposed in market based on these sensors.



Fig. 1.2.1.1 The implemented MCU board for the control of sensor and LED

Smart Personal Sensor Network Control for Energy Saving in DC Grid Powered LED Lighting System proposed by Yen Kheng Tan in 2012 on IEEE. [2]

This paper was proposed in 2012 which focused on saving energy efficiently using low power DC grid instead of AC power. It does not have automatic control system, but it has a feature of controlling energy automatically. It has ability to perform similar lighting even in low voltage because it is using DC power which is to be converted from AC power to perform efficiently. But there is no sensing capability to turn off or on the switches automatically.

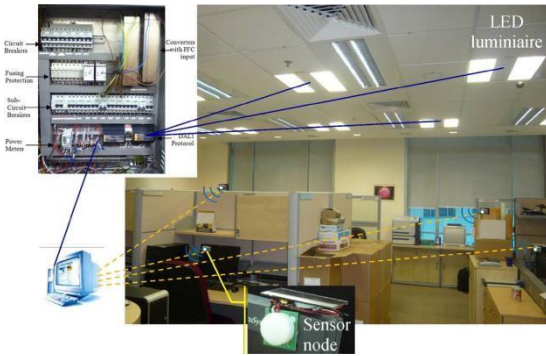

Fig. 1.2.1.2 Deployment of smart personal sensor network control for energy saving in dc grid powered LED lighting system

Development of Smart LED Lighting System Using Multi-Sensor Module and Bluetooth Low Energy Technology proposed by Young Seek Cho, Jaerock Kwon, Seyeong Choi and Dae-Hee Park in 2014 IEEE SECON Posters IEEE International Conference on Sensing, Communications and Networking (SECON). [3]

This paper was proposed in 2014 which developed a smart bulb which can be controlled through communicate via Bluetooth to control the function of bulb. It has so many sensors like temperature measuring sensor, light intensity sensor and many more. But this system is depending on your instructions. This system does not operate automatically. Bluetooth is not a strong medium as compare to Wi-Fi or others.

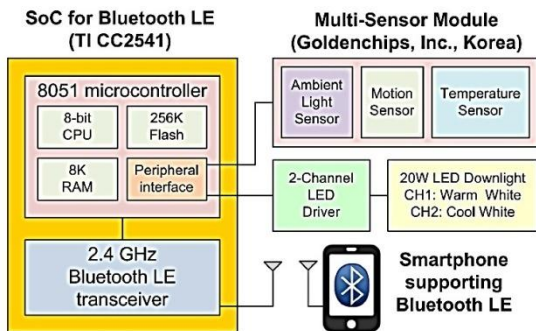

Fig. 1.2.1.3 High level block diagram of the proposed LED lighting system

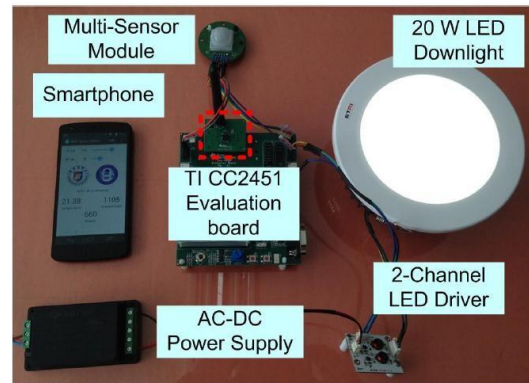

Fig. 1.2.1.4 A picture of the smart LED lighting system implemented

A low cost, highly scalable Wireless Sensor Network Solution to achieve smart LED light control for Green Buildings proposed by M. Magno, Member, IEEE, T. Polonelli, L. Benini Fellow, IEEE, E. Popovici, Senior Member, IEEE published in 2015. [4]

This paper was published in 2015 based on wireless sensor to control the light bulbs. They were using wireless sensors and control it manually to save electricity especially for offices. This system was not automatically controlled. The system combines motion sensors and light sensors in a low power wireless solution using Zigbee communication.

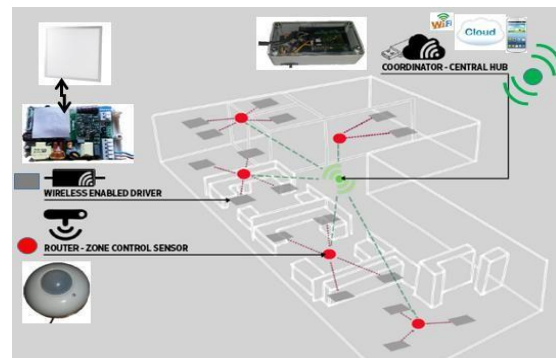

Fig. 1.2.1.5 Smart Lighting

A Smart LED Lighting with Multiple Dimming and Temperature Automatic Protection Capabilities proposed by Kai-Lun Chen a, Hao-Ping Chan b, Yu-Cherng Hung c, Shao-Hui Shieh d in 2016 International Symposium on Computer, Consumer and Control. [5]

This paper was proposed in 2016 which was based on temperature control sensors and lighting sensors. They focused on night lamp because when your lamp is on for whole night, it produces

heat which can damage your lamp as well as your sensors, so when the temperature goes high it turns off the light or dimming the light for protection. So this system is based on temperature, when temperature goes high it will automatically switch off the bulb. But on the basis of heat it does not save energy efficiently because till high temperature it consumed enough energy as well. That is why this system is not that much effective as our system is.

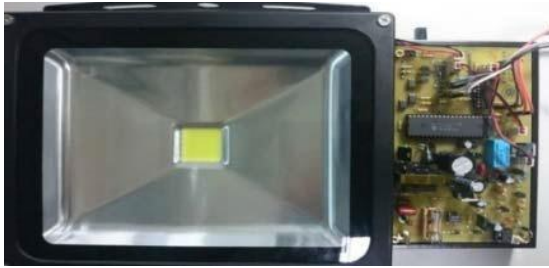

Fig. 1.2.1.6 LED lamp system

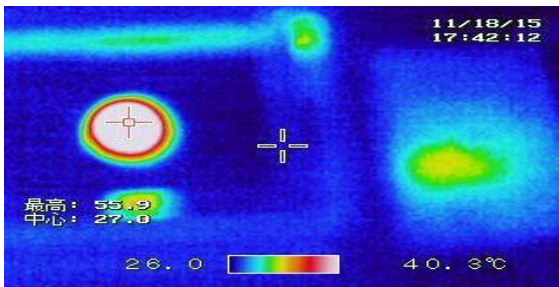

Fig. 1.2.1.7 The temperature distribution

Even there so many companies like Philips and many more proposed a smart bulb which can be controlled through your smartphone using Wi-Fi and GPS. As per their implementation closure they didn't published their idea of forming smart bulb.

3. PROBLEM STATEMENTS

Existing system is not intelligent enough to sense when is should be turn off or on. It is manually controlled through smartphone, it has convenience of remote access but when you are sleeping or when you are not at your house, you have to check whether it is on or not then you may turn off or on it, some kind of effort and concern are required in this system. That is why this system is lacking somewhere which is required to overcome.



Fig. 3.1 Target Place



Fig. 3.2 Control via Smartphone

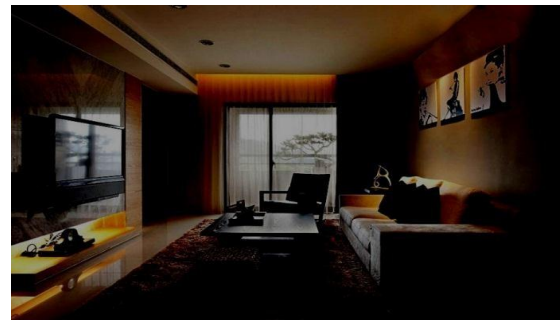

Fig. 3.3 Bulb Controlled via Smartphone

4. PROPOSED WORK

4.1 Smart Light Bulb:

In this system there will be a camera which will be able to recognize changes on the basis of your triggered background image and works automatically. It means that a light integrated with camera which is able to sense if there is a person in a room or not and it is also able to sense your activity whether you are sleeping or not and accordingly it turn off or on. Suppose you are working with your laptop in your living room as figure 4.1.1 given below.



Fig. 4.1.1 Working on Living Room

Suddenly you got sleep, then by present smart LED it is impossible to turn off light automatically, you will have to turn it off either by your smartphone or your switch.



Fig. 4.1.2 Sleep Detection

But the proposed system will sense your movement till 1 hour and accordingly it will turn off your bulb automatically as figure 4.1.3 given below.



Fig. 4.1.3 turned off after sleep detection

One more feature is that, suppose you are working in your living room or somewhere else and after a while you

went to sleep or you went somewhere else then in this case tradition bulb will remain turned on till you do not switch it off and if it is smart LED then you have to turn off it by your smartphone but if you are sleeping then how you will switch it off or if you are not in your home and you forgot to check via your smartphone then it does not turned off automatically. But proposed system has ability to sense if you are not in your room for half an hour then it will turned off your bulb automatically, then whether you are sleeping in your bed room or you are not in your home or you forgot to switch off your bulb.



Fig. 4.1.4 Working on living room



Fig. 4.1.5 No one is detected in room Fig.

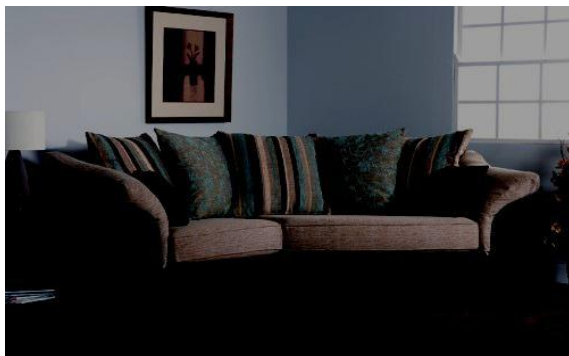

Fig. 4.1.6 turned off after detection

5. PROPOSED METHODOLOGY

The proposed methodology is depending on the image processing, we will convert the images as per convenience for change detection using histogram difference. First of all we will get a triggered image as per your desired frame, then generate an RGB image and convert it into grayscale, after this we will generate its histogram and compare it with the real time video for change detection, human motion detection and hand posture recognition signal.



Fig. 5.1.1 Presence Detection



Fig. 5.1.2 Sleep Detection

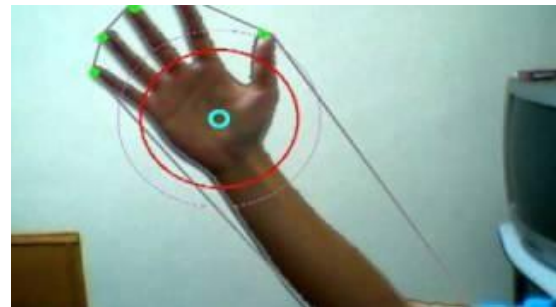

Fig. 5.1.3 Hand Recognition Signal

We are going to use various approaches of image processing through MATLAB. Let it be more precise by flowchart.

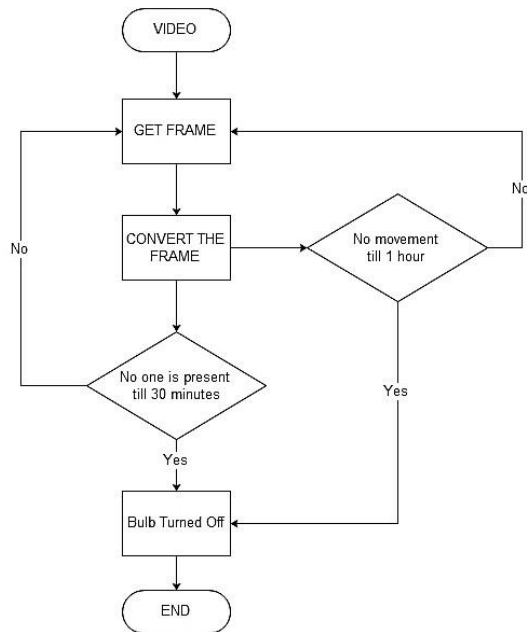

Fig. 5.1.4 Flow Chart

6. CONCLUSION

Thus the real time vision based smart bulb avail you to save your electricity automatically and also save you and your house from electrical casualty. The present system has no potential to works or sense automatically but the proposed one will definitely avail you an intelligent bulb which turn your life easier as you think. Because we are going to the era of automation where everything will be operated automatically and intelligent enough to work accordingly and known for best decision making.

7. FUTURE SCOPE

The current proposed concept of real time vision based smart bulb definitely get enhanced in future because we can also develop a system which can control you home appliances automatically using intelligent approach like your fan, cooler, television and many more which will turn you stress less.

8. REFERENCES

- [1] Smart LED lighting system implementation using Human tracking US/IR sensor proposed by Daeho Kim¹, Junghoon Lee¹ and Yeongmin Jang², Jaesang Cha^{1*}in 978-1-4577-1268-5/11/\$26.00 ©2011 IEEE.
- [2] Smart Personal Sensor Network Control for Energy Saving in DC Grid Powered LED Lighting System proposed by Yen Kheng Tan in 2012 on IEEE.
- [3] Development of Smart LED Lighting System Using Multi-Sensor Module and Bluetooth Low Energy

Technology proposed by Young Seek Cho, Jaerock Kwon , Seyeong Choi and Dae-Hee Park in 2014 IEEE SECON Posters -- IEEE International Conference on Sensing, Communications and Networking (SECON).

- [4] A low cost, highly scalable Wireless Sensor Network Solution to achieve smart LED light control for Green Buildings proposed by M. Magno, Member, IEEE, T. Polonelli, L. Benini Fellow, IEEE, E. Popovici , Senior Member, IEEE published in 2015.
- [5] A Smart LED Lighting with Multiple Dimming and Temperature Automatic Protection Capabilities proposed by Kai-Lun Chen ^a, Hao-Ping Chan ^b, Yu-Cherng Hung ^c, Shao-Hui Shieh ^d in 2016 International Symposium on Computer, Consumer and Control.