

# Analytical and Comparative Analysis of Ofdm, Cdma & Idma Systems

Chirag R. Shah

Mumbai, India

**ABSTRACT** -- Today, as we can experience the advance of communication, we have come across rapid growth in wireless technology. Owing to this we have evolved from various wireless communication technologies starting from 1<sup>st</sup> generation to 2<sup>nd</sup>, then to 3<sup>rd</sup> & now we have reached to 4<sup>th</sup> generation communication technology. The basic idea of this paper is to analyze OFDM, CDMA & IDMA systems and to find out their response to ISI, ICI, interference, comparing their data rate & speed so that we can get to know how their use & applications in order to enhance wireless communication which can lead us to 3G & 4G communication by using them individually & also by combining them.

**Keywords** – orthogonality, interleaving, multi-user detection, unique sequence code, multiplexing, BER (Bit Error Rate).

## I. INTRODUCTION

The 1<sup>st</sup> Generation communication system was completely based on analog communication medium, due to this the data rate and the speed obtained was much less, and therefore there was a realization to switch from analog medium to digital communication medium.

Multiple Access Technology is been used extensively to implement wireless communication system over the years. As per the increasing demand of high speed, Bandwidth & data rate (which form the parameters to judge & compare all the available technologies), there was a need to go beyond the current available multiple access technology, & this laid down the foundation of various advanced concepts in wireless communication. Earlier the communication was based on FDMA/TDMA technique, which has very less Bandwidth & data rate and this cannot meet the growing demand.

In FDM the symbols are simply multiplexed & are distributed in such a way that each time slot will have only one symbol (as shown below in fig.1), but this not a time efficient process. Due to this we have move further to OFDM.

In OFDM we used the concept of orthogonality, where we can transmit multiple symbols/channels in a single time slot (as shown below in fig.1), since the symbols are orthogonally multiplexed.

Here in OFDM the neighboring symbols are overlapped which is discussed in more details further.

It was found out that OFDM system has much more Bandwidth & data rate compare to FDM system which makes it more suitable over FDM.; But here since there are more than one symbols in one single time slot the occurrences of ISI(Inter Symbol Interference) & ICI(Inter Channel Interference) which results in loss of information.

Now, moving further to CDMA (Code Division Multiple Access) system from FDMA, where the symbols are distributed on entire bandwidth & are identified by unique sequence code assign to each symbol for its identification. This increases the speed to a greater extend but it introduces the problem of MAI (Multi Address Interference), the solution to this is MUD (Multi-User Detection) algorithm but the implementation of it is very difficult (it becomes very complex due to multi address and which ultimately results in interference between the adjacent symbol, hence reducing the data rate & efficiency of this system), which makes this system quite unreliable [1].

Further, to overcome the complexities of CDMA system, we have reached to IDMA system. The Interleaver is the heart of IDMA system. IDMA is simply an enhanced version of CDMA concept wherein different interleavers are used for the separation of symbols, & the main advantage of using IDMA is that, it protects the symbols from fading which requires the use of MUD algorithm in CDMA & makes CDMA a complex solution to it. IDMA also supports the use of turbo-codes [1]. Since the concept of CDMA is restricted till MAI (Multi Access Interference) & ISI, IDMA is proposed over CDMA [1].

## II. OFDM SYSTEM

In FDMA single wide-band subcarrier was used to transport data and due to this it was highly time consuming; hence to go beyond it we came to OFDM system where large number of parallel narrow-band sub-carriers can be transferred over a single time slot maintaining the condition of orthogonality, this forms the basic idea behind OFDM system.

Over the time OFDM has been a revolution in the field of communication technology, since all the further multiplexing techniques are related to

OFDM. Since it gives very high bandwidth it is not only used in 3G & 4G concepts but it is also used excessively in all the high frequency applications [1].

Here orthogonality indicates the overlapping of the symbols in single channel as shown below; which states that multiple symbols overlapped each other in single time slot, which increases the time efficiency of this system to higher extend since due to this overlapping, bandwidth usage can be optimized [2]. It is found out that by using overlapping we can save up to 50% of bandwidth [2]. In order to maintain orthogonality the spacing

$$\Delta f = \frac{k}{T_u} \text{ Hertz}$$

between sub-carrier must be

where,  $T_u$  sec. indicates the duration of symbols & k is an positive integer typically equal to 1; and to satisfy orthogonality the bandwidth must be

$B \approx N \cdot \Delta f(\text{Hz})$  where N is the number of sub-carriers in one time slot as shown below[2]. Orthogonality can be mathematically expressed as

$$\int \cos(2\pi n f_0 t) \cos(2\pi m f_0 t) dt = 0 \quad \text{where } (n \neq m) \quad (1) [2].$$

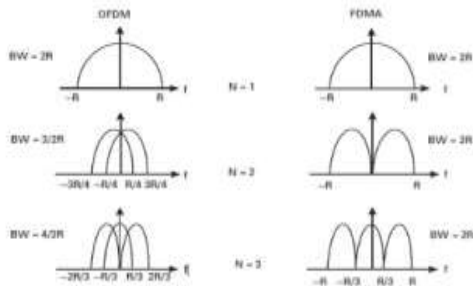

Fig.1: Concept of OFDM signal and orthogonality [2].

The modulation technique used for OFDM is QPSK, BPSK [2][3]. Following is the block diagram for transmission & reception of signals in OFDM.

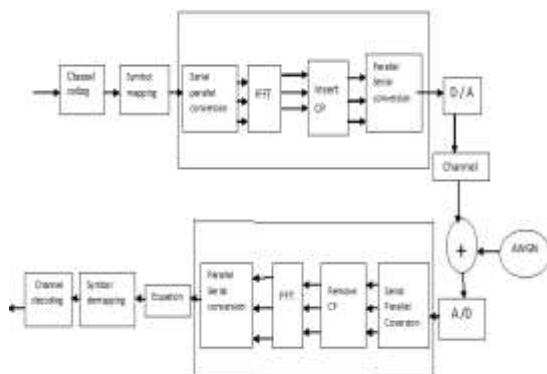

Fig.2: OFDM system [1].

As discussed above, we can transmit multiple carriers at a time; this depends on two conditions viz. availability of spectral bandwidth and the size of IFFT (higher the complexity of OFDM more is size of IFFT) [2]. Now since here two symbols are overlapping, it is possible that ISI (Inter Symbol Interference) can occur, hence in order to avoid it we use Cyclic Prefix (CP) [1]. This is done by simply inserting a guard band (symbol which is not required or simply a dummy symbol) between two symbols during transmission which is removed at the receiving end so that we can get the same symbol at the receiving end which is transmitted [1]. Then the symbols are converted from parallel to serial and are transmitted over AWGN or any available channel at the receiving end, where reverse process is done so as to get the original signal. Due to use of CP, OFDM becomes much more reliable than FDMA.

OFDM, having so many advantages as discussed above, the major constrain is to maintain orthogonality, which is overcome by using CP but this reduces the efficiency of bandwidth i.e. (as discussed, we save up to 50% of bandwidth), since guard band also occupies the channel. Also if orthogonality is lost then the channel fades. Due to above mentioned difficulties in OFDM it is required to move over to some other multiplexing technique which can give easy solution to above complexities.

### III. CDMA SYSTEM

The approach used in CDMA technology is quite different as compared to OFDM system. In this case the concept of orthogonality doesn't exist. Instead here unique sequence code is used [1] [5]. Here the symbols are spread across the available bandwidth for transmission & to each transmitted symbol a unique sequence code is assigned [1] [5]. This unique sequence code signifies the position of the occurrences of symbols i.e. it indicates that which symbol is preceded by the current symbol [1]; this forms the major difference between OFDM & CDMA. Due to this concept CDMA has brought a major revolution as it is the basic platform form for 3<sup>rd</sup> generation mobile communication [5]. The combination of CDMA along with OFDM can yield a better system for the performance of 3G communication system [1]. Following block diagram indicates that how CDMA transmission & reception works.

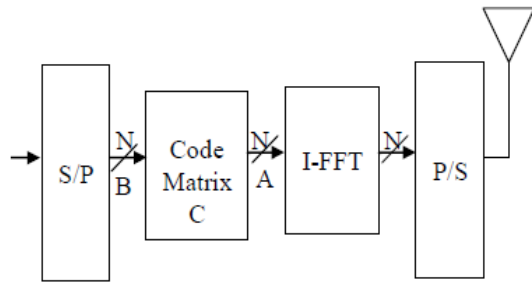

Fig.3: CDMA system transmitter [4].

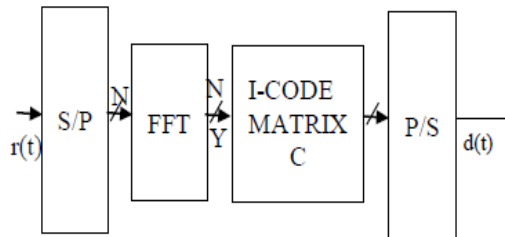

Fig.4: CDMA system receiver [4].

In CDMA, unlike OFDM similar symbols (in analogues) can be transmitted over a certain subcarrier & are spread over entire subcarrier [4] [5] [1]. Due to this the data flow at the input side is increased significantly [4]. Even in CDMA CP is required so as to overcome the problem of ISI. Lastly, in the above shown diagram IFFT & FFT is used so as to convert symbols from serial to parallel & vice versa at the receiving end. For the processing of symbols in CDMA technology, Walsh code is used; which is a square matrix in which all the rows are orthogonal to each other and similarly all the columns are orthogonal to each other & this matrix is generated by using Hadamard transformation [4]. The multiplexing technique used in CDMA is Spread Spectrum [4]. Since in CDMA all the symbols gets spread over the bandwidth they get disturbed in the order and at the receiver end it becomes very difficult to test the sequence of codes; which increases the complexities of this system, also the performance of CDMA is limited by MAI(Multi Access Interference) [7], due to this the system encounters fading and due to this it was required to go beyond this to IDMA which can handle this problem efficiently.

#### IV. IDMA SYSTEM

After going through OFDM & CDMA systems & the difficulties in them we reached to IDMA (Interleave Division Multiple Access), where Interleaver is the heart of IDMA technology. It is the most recent multiplexing technique which has boost up the data rate and bandwidth efficiency of digital communication to a larger extent. Interleaver is also used in CDMA but in CDMA its

is used for coding gain; whereas in IDMA it replaces the unique sequence code of CDMA; here in IDMA, Interleaver is used for the separation of multiple symbols [7]. This concept of using interleavers for separation minimizes the probability of fading and signal loss [1]. Therefore we can say that IDMA is nothing but a special form of CDMA system [1].

Let us now see the block diagram in detail

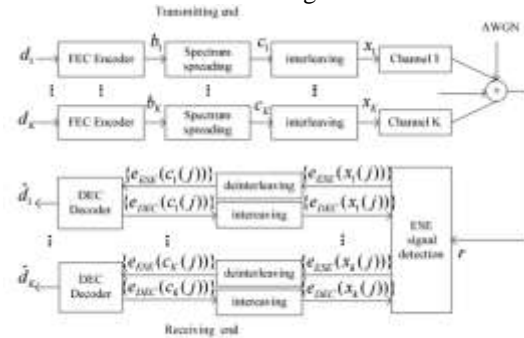

Fig.6: Block diagram of IDMA system [1].

In IDMA each transmitting signal is encoded using FEC encoder at low rate coding [1]. The idea behind the use of FEC is that it gives many advantages viz it stands as one of the best encoding scheme available; it protects the data from getting corrupt or simply it avoids fading of symbols. Further all the symbols are then spread over the channel available along with the concept of interleaver mentioned earlier. Different types of interleaver can be used like Random Interleaver, Block interleaver, Tree Based Interleaver [7]. Further ESE (Elementary Signal Estimator) is used; which accepts the signals from channels for receiving the transmitted data and detects the sequence of incoming signals. The major advantage of using IDMA over CDMA is that it eliminates MUD & MAI much more efficiently than CDMA, which makes this system much more reliable than any other available multiplexing techniques for communication technology. In the further section we will see the comparison of all the above mentioned multiplexing techniques, which will give us a clear view of their processing.

#### V. COMPARISON/PERFORMANCE PARAMETER BER (Bit Error Rate)

BER is considered to be the most important parameter for the analysis of various technologies in digital communication system. It can be defined as the percentage of bits which are corrupt within the total available bits; it is usually expressed in the negative power of 10 [1]. By using BER we can get to know the amount of data affected by interference & this indicates that how much of data needs to be retransmitted [1]. BERT(Bit Error Rate Testers) is used to measure BER [1].

Mathematically, BER is given as [1],

$$\text{BER} = \text{No. of Error Bits/No. of Total}$$

BER occurs into the system due to the interference of noise into the system & it may happen when the flow of symbol pattern changes abruptly. For any system to work properly it is significant to have an optimized BER value & it is required to maintain the signal to noise ratio in a proper proportion so as to achieve this. BER of a system mainly affects 3 parameters viz. Interference, Transmission Power, Bandwidth [1]. To have optimized BER result bandwidth should be low & lower modulation levels, but both of the two will reduce the efficiency of the system & it adversely affects the throughput of the system, this is the only difficulty encountered in BER. Therefore the analysis must be done carefully keeping all this into consideration, here in this article BER is used as the parameter for analysis since it gives the most appropriate results.

**VI. COMPARISON OF OFDM, CDMA & IDMA**

The above mentioned three systems can be compared on the basis of various parameters which can give us the better understanding of all of them. Following table give the comparison of them. Table I: Comparison of OFDM CDMA & IDMA System.

Sr No.	Parameters	OFDM	CDMA	IDMA
1	BER	Lower than CDMA & IDMA.	Comparatively better than OFDM but poor than IDMA due to MUD problem [3].	Very good BER due to the use of interleavers.
2	Throughput	Good but affected by parameters like radio frequency & path [9].	Increased by code-correlation [10]. But this increases the probability of MUD.	Comparatively very high throughput [8].

3	MUD	It decreases the complexities, but it also reduces the system performance [11].	It is very complex, due to which the efficiency of system decreases [3].	Better since it is used along with chip – level interleavers [7].
4	ISI & ICI	Good but adversely affected if orthogonality among the symbols is lost	Can be overcome but it becomes difficult to avoid due to the use of MAI.	It gives satisfactory results as compared with OFDM & CDMA.

**VII. RESULTS & DISCUSSIONS**

In this paper we have analyzed the OFDM system in presence of noise as shown below. Thus we have gone for CDMA system & finally we implemented IDMA system. On comparison of all three we can reach to a point that IDMA yields better results amongst the three in accordance with the comparison table.

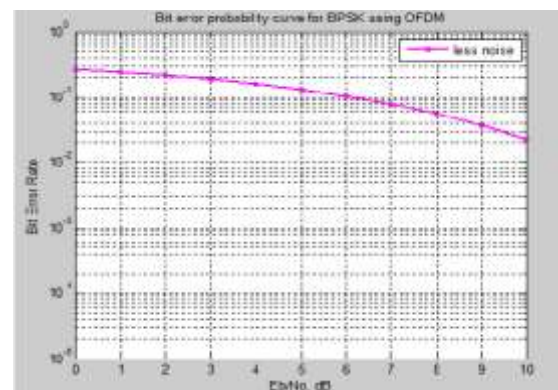

Fig.6: BER response of OFDM system [1].

The above curve indicates the BER analysis of OFDM system in presence of noise. Further this result is compared with CDMA to yield the better among this two.

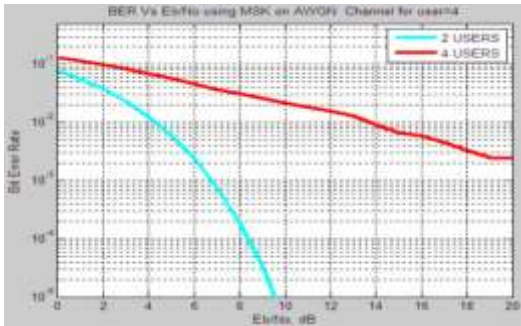

Fig.7: BER response of CDMA system [4].

We now have analyzed above curve which is a BER curve for CDMA system (here we have considered CDMA for 2 users) in presence of noise.

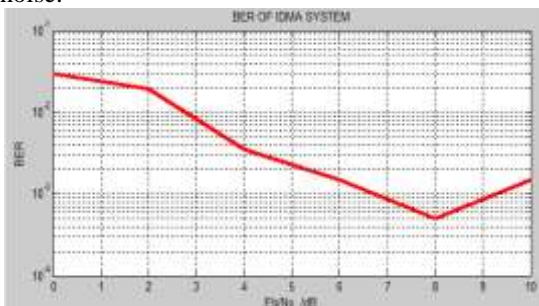

Fig.8: BER response of IDMA system.

Lastly, we have implemented IDMA system so as to complete the analysis & get the best one out from the above 3 results. The comparison of above three BER curves can be studied in more detail in below mentioned table which gives the values of BER at different SNR values for all the three curves.

The following table consists of different BER values for all the three curves which are taken at different SNR values (in dB). Referring the below table we can clearly say that which of the three technologies is optimum, also it gives an idea that which of them can be used for further communication technology. Lastly, it indicates which of the three gives better BER results which can lead us to conclude this comparison.

Table II: Comparative Analysis of OFDM CDMA & IDMA System.

BER \ SNR (in dB)	OFDM	CDMA	IDMA
0	0.2645	0.9	<b>0.03</b>
2	0.2132	0.082	<b>0.0195</b>
4	0.1575	0.055	<b>0.0035</b>
6	0.1035	0.041	<b>0.0015</b>
8	0.005573	0.036	<b>0.0005</b>
10	0.002252	0.013	<b>0.0015</b>

## VIII. CONCLUSION

On analyzing OFDM, CDMA & IDMA we can say that, with the increasing demand of high speed, data rate & efficiency in digital wireless communication, IDMA has been revolutionary over the two; & hence it can play a very important role in further communication techniques.

IDMA in itself has many advantages moreover, it also inherits all the advantages of CDMA technology which enhances its range of applications. The heart of IDMA is interleaver, which optimizes the memory utilization to a larger extent & increases the efficiency of IDMA system.

It is very much clear from table II that IDMA has got the optimum BER (Bit Error Rate) results amongst the three. Due to this IDMA can be used in applications like 4<sup>th</sup> Generation mobile communication. For 3<sup>rd</sup> G communication combination of OFDM-CDMA can be used, which is further enhanced by using OFDM-IDMA for 4<sup>th</sup> G communication, since it consists of all the advantages of CDMA & also it reduces the complexities in CDMA. Hence we can say that IDMA is one of the best available technologies for future wireless communication.

## REFERENCES

- [1] Chirag R. Shah, Department of Electronics & Telecommunication Engineering, University of Mumbai, Performance and Comparative Analysis of OFDM, OFDM-CDMA & OFDM-IDMA Systems, International Journal of Engineering Research & Technology (IJERT), Vol. 5 Issue 04, April-2016
- [2] G. Banupriya & D. Thilagavathi, M. Phil Scholar, Department of Computer Science, NGM College, Pollachi, India & Asst. Professor, Department of Computer Science, NGM College, Pollachi, India, Features and Principles of OFDM: A Brief Study, International Journal of Innovative research in Computer and Communication Engineering, Vol 4, Issue 8, August 2016
- [3] Zhen Hua Wang, Ge Fe Yu, Xi Cheng, Jie Yang, Yin Tin Wang, "STUDY ON SIMULATION PERFORMANCE OF OFDM-IDMA SYSTEM." Proceedings of the 2nd International Conference on Computer Science and Electronics Engineering (ICCSEE 2013).
- [4] Manjinder Singh & Karamjeet Kaur, M.Tech, ECE & Assistant Professor, Ucoee, Department Ucoee, Department Punjabi University, Patiala, BER Performance of MC-CDMA Using Walsh Code with MSK Modulation on AWGN and Rayleigh Channel, International Journal of Engineering Trends & Technology (IJETT), Vol 4, Issue 7, July-2013.
- [5] Rajeev Yadav, CDMA Technology, 1st\_prize\_CDMA\_Technology\_Rajeev\_Yadav.
- [6] Li Ping, Li Hai Liu, K.Y. Wu & W.K. Leung, Department of Electronics Engineering, City University of Hong Kong. IDMA communications.
- [7] Kuldeep Choudhary, P S Sharma, Department of Electronics & Communications, Tula's Institute, Dehradun-248001, India & Dehradun Institute of Technology, Dehradun-248001, India, Interleavers for IDMA Technology: A Comparison Survey, International Journal of Advanced Research in Computer and Communication Engineering Vol. 1, Issue 2, April 2012.
- [8] Li Ping and Lihai Liu, Department of Electronic Engineering, City University of Hong Kong, Hong Kong.

Analysis and Design of IDMA Systems Based on SNR Evolution and Power Allocation, 2004 IEEE.  
[9] Keith Mayes & James Larsen, WhitePaper\_odmaIntro, ODMA Opportunity Driven Multiple Access.  
[10] Hossam Shalaby, Alexandria University, Complexities, error probabilities, and capacities of optical OOK-CDMA

communication systems. IEEE Transactions on Communications · January 2003.  
[11] Ming Jiang, Member IEEE, and Lajos Hanzo, Fellow IEEE, MultiuserMIMO-OFDM for Next-Generation Wireless Systems, Proceedings of the IEEE | Vol. 95, No. 7, July 2007.