

Comparative Analysis of Advanced Modulation Formats Over 8 Channel Bidirectional WDM-PON

Harmanjot Singh¹, Gagandeep Singh², Chamanjot Kaur³

¹Assistant Professor, Department of Electronics, Punjabi University, Patiala

²M.tech Scholar, Department of Electronics, Punjabi University, Patiala

³Assistant Professor, Department of Electronics, Adesh University, Gharuan

Abstract— with the growing demand of users higher speed reliable data transmission become the great need for the users. For the higher bit rate and flexible bandwidth wavelength Division Multiplexing (WDM) network is one of the best solutions. The performance of WDM mainly depends upon various factors such as modulation format, channel selection, amplifiers etc. used in the networks. In this paper comparison of various Advanced Modulation Formats has been carried over the 8 channel Bidirectional WDM PON with data rate of 40Gbps. In this, the system performance is not increased by using any sort of amplifiers and DCF. The designed system has achieved maximum transmission distance of 110 km over Bidirectional multimode fiber. This simulation work has done in optisystem 14.1 suite software.

Keywords—PON (Passive Optical Network), DCF (Dispersion Compensation Fiber), MZI (Mach Zender Interferometer), OLT (Optical Line Terminal), ONU (Optical Network Unit, WDM (Wavelength Division Multiplexing, MMF (Multimode Fiber)

I. INTRODUCTION

With the advancement in the communication systems, there is a need for large bandwidth to send more data at higher speed. Residential subscribers demand high speed network for voice and media-rich services. Similarly, corporate subscribers demand broadband infrastructure so that they can extend their local-area networks to the Internet backbone. This demands the networks of higher capacities at lower costs. Our current “age of technology” is the result of many brilliant inventions and discoveries, but it is our ability to transmit information, and the media we use to do it, that is perhaps most responsible for its evolution [1]. Progressing from the copper wire of a century ago to today’s fiber optic cable, our increasing ability to transmit more information, more quickly and over longer distances has expanded the boundaries of our technological development in all areas. Optical communication technology gives the solution for higher bandwidth. By developing the optical networks, larger transmission capacity at longer transmission distance can be achieved [2]. To accomplish higher data rates, these optical networks

will be required fast and efficient wavelength conversion, multiplexing, optical splitter, optical combiner, arithmetic processing and add-drop function etc.

The access network, also known as the “first-mile network”, connects the service provider central offices (COs) to businesses and residential subscribers. This network is also referred to in the literature as the subscriber access network, or the local loop. The bandwidth demand in the access network has been increasing rapidly over the past several years. Residential subscribers demand first-mile access solutions that have high bandwidth and offer media-rich services. Similarly, corporate users demand broadband infrastructure through which they can connect their local-area networks to the Internet backbone. It is estimated that there would be a bandwidth demand of 10 Gbps or more, around year 2010, and over 40 Gbps in year 2020 [3].

PON stands for Passive optical network, a technology that modulates the light wave from optical line terminal (OLT) that locates at central office (CO) and transmits it through fiber to optical network units (ONUs) that locates at end user. It is designed to provide virtually unlimited bandwidth to the subscriber. The system can be described as fiber-to-the-curb (FTTC), fiber-to-the building (FTTB), or fiber-to-the-home (FTTH) and we can define it as point to multipoint [PMP] topology and uses single optical fiber to serve multiple premises [4].

Although PON technology is mature for backbone networks, its user handling capacity and longer transmission distance is still considered for access networks. From literature survey, we came across a number of suggested ways i.e. use of advanced modulation formats to mitigate the effect of non-linear ties in multi-channel WDM-PON at narrow channel spacing enhance the total system capacity. Also, there is a need for longer transmission length which can be solved by using Advanced Modulation Formats. These formats not only increase the system length but also increase system security as the data is encrypted as they are modulated [5]. Various Advanced Modulation Formats are NRZ (Non Return to Zero), RZ (Return to Zero), CSRZ (Carrier

Suppressed Return to Zero), DRZ (Duo binary Return to Zero) and MDRZ (Modified Duo binary Return to Zero). Performance of WDM Passive Optical Networks on high data rates decrease with the increase in number of users. Today there is only one need that the rate of transmission of data will be increase with maximum link length and maximum number of users [6]. So to achieve this need we have designed 8 channel Bidirectional WDM PON based system which will be discussed in the next section. Bi-directionality of an optical fiber further increases the network capacity.

II. SIMULATION SETUP OF 8 CHANNEL BIDIRECTIONAL WDM PON

The block diagram of 40Gbps, 8 channel Bidirectional WDM PON system is shown in Fig 1. The discussed transmission system consists of three parts: transmitter, fiber link and receiver. The transmitter and receiver part acts as transceivers as the system is bidirectional. The transmitter part consists of Laser source, modulators, bidirectional circulator and raised cosine filter. The receiver block consists of synchronization/timing extraction circuit, bidirectional splitter, Bessel filter and 3R regenerator. Table1 represents the specifications of 8 channels Bidirectional WDM PON System. Proposed system consists of a laser wavelength of 1550nm, frequency 193.1 THz, power varied from 0 dBm to 20 dBm, channel spacing varied from 25 GHz to 200 GHz attenuation factor of 0.2dB/km and beam divergence of 0.2 mrad. At input a laser array is used, this array consists of 4 distinct frequencies. All channels are multiplexed by wavelength division multiplexing and every channel transferred its own information without interfering other channels. In this way it reduces the inter symbol interference effect. At transmitter side instead of simple modulator different advanced modulation formats are being used which also helps in reducing certain nonlinearities present in channel. Various amplifiers and dispersion Compensation Fiber (DCF) are not used in the system. Also, the fiber used is Bidirectional multimode fiber. When signal propagates from the channel then it is easily affected by the atmospheric effects so in order to remove high frequency components signal passes through the Bessel filter which remove non-linear and high frequency components along with certain harmonic components and at last signal is analyzed by the BER analyzer followed by 3R regenerator. This 3R regenerator helps in providing the 3 inputs to BER analyzer as system contains subsystem at both the ends. The prototype model is analyzed by varying its power, distance and channel spacing. Fig1 represents the designed 8 channel Bidirectional WDM PON based system in which we use Advanced Modulation Formats. The data from this passed to the WDM mux, whose main purpose is to multiplex the signal and transmit over a bidirectional fiber with minimum intersymbol interference.

Table 1 showing System Specifications

Pulse generator	NRZ
LASER Wavelength	1550nm
Frequency Spacing	25GHz-200GHz
Power (in mw)	5dBm-20dBm
Attenuation	0.2 dB/km
Responsivity	1A/W
Dark Current	10Na
Optical Fiber	Bidirectional MMF
Amplifier used	none
Distance	50km-100km
Multiplexing Technique	WDM
Number of users	8

The use of bidirectional circulator is to provide isolation between the different signals at the input while at the output bidirectional splitter can act as Power splitter as well as Power combiner. The subsystem used at both the sides consists of Advanced Modulation formats as well as pulse generators etc.

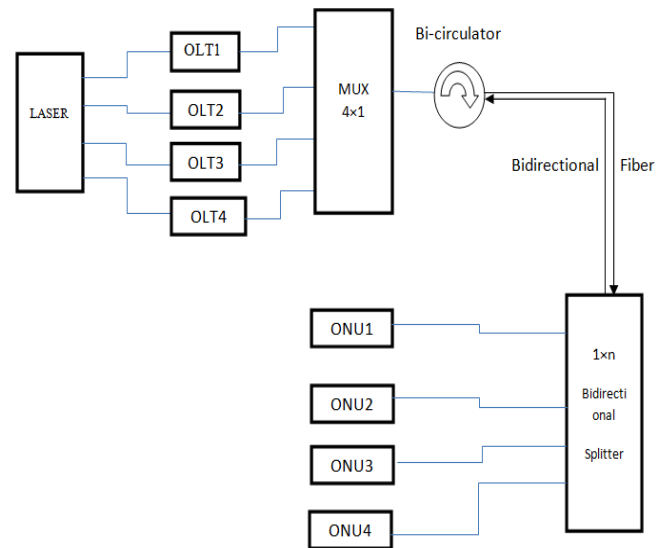

Figure 1: Simulation Setup of 8 channel Bidirectional WDM PON system

In PON transmitter side is called OLT (Optical Line Terminal) while receiver is called ONU (Optical Network Unit). Due to the Bi-directionality of the system OLT can act as ONU and vice versa. After the signal transmitted through the transmission link, it is demultiplexed by device splitter. On the receiver side the signal is send to the Photo detector PIN, Bessel filter and then to BER analyzer. BER is used to analyze the received signal in terms of Q-factor, BER and eye height etc.

III. RESULTS AND DISCUSSION

Advanced Modulation Formats like NRZ (Non Return to Zero), RZ (Return to Zero), CSRZ (Carrier Suppressed Return to Zero), DRZ (Duo binary Return to Zero) and MDRZ (Modified Duo binary Return to Zero) are compared by varying three parameters that are

- 1) Power
- 2) Distance
- 2) Channel Spacing

For each parameter varied, other two parameters were kept constant.

1) Analysis by varying Power: Distance and channel spacing were kept constant at 90km and 150GHz resp.

Table 2: shows Q factor comparison of various modulation formats by varying Power.

POWER (dBm)	NRZ	RZ	CSRZ	DRZ	MDRZ
0	4.3126	0	0	5.0249	0
6	4.20524	2.35025	3.22337	6.1161	6.1014
10	4.1086	5.0651	5.43051	7.2926	8.2738
15	3.65981	4.9952	7.49002	4.06708	8.7684
20	3.25874	4.25487	7.7944	3.31246	6.17321

These values when plotted on graph shows following results.

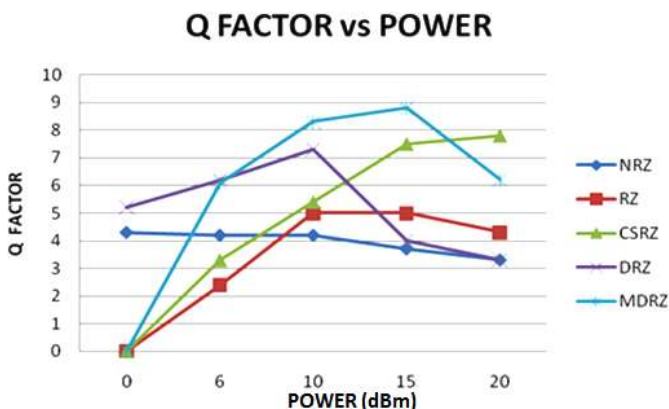

Fig 2 showing Q factor vs. Power graph for various modulation formats

2) Analysis by varying Distance: Power and channel spacing were kept constant at 10dBm and 150GHz resp.

Table 3 shows Q factor comparison of various modulation formats by varying Distance

Distance km	NRZ	RZ	CSRZ	DRZ	MDRZ
50km	7.9953	8.8682	11.9584	10.594	9.5420
70km	5.5247	6.5529	8.2883	8.7952	10.3826
90km	4.1348	5.0656	5.3842	7.4684	8.1536
110km	2.0145	2.2785	3.1195	3.3266	5.86949

These values when plotted on graph shows following results

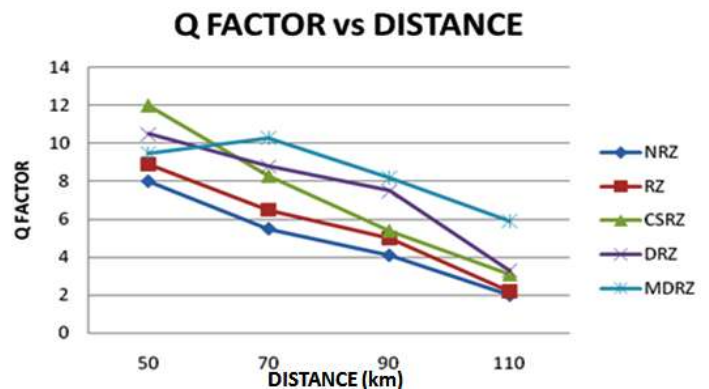

Fig 3 showing Q factor vs. Distance graph for various modulation formats

3) Analysis by varying Channel Spacing: Distance and power were kept constant at 90km and 10dBm resp.

Table 4 shows Q factor comparison of various modulation formats by varying Channel Spacing

Channel Spacing	NRZ	RZ	CSRZ	DRZ	MDRZ
25 GHz	3.4622	5.1661	5.6719	7.2198	3.8972
75 GHz	4.40612	5.2177	5.1473	7.3935	3.6807
125 GHz	4.0906	5.3185	5.430	7.5206	3.4698
150 GHz	4.1158	5.5273	4.7875	7.6234	8.2998
200 GHz	4.00612	4.8274	5.3369	7.3185	7.8557

These values when plotted on graph shows following results

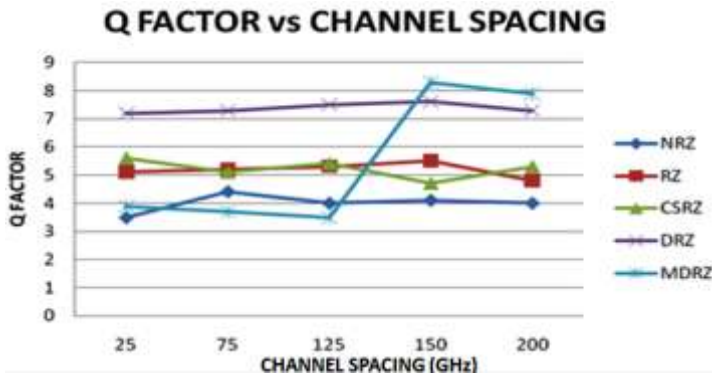
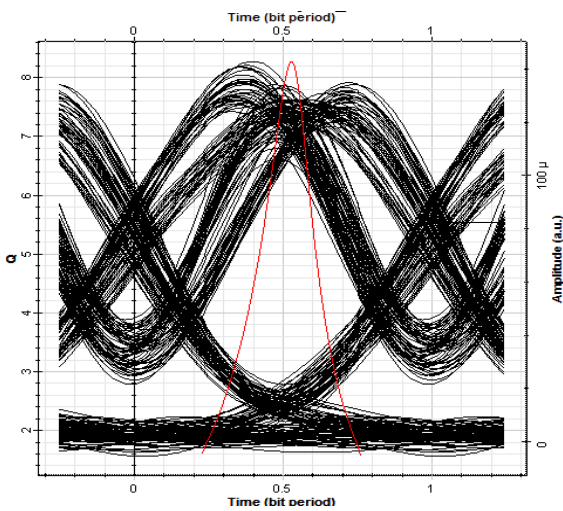
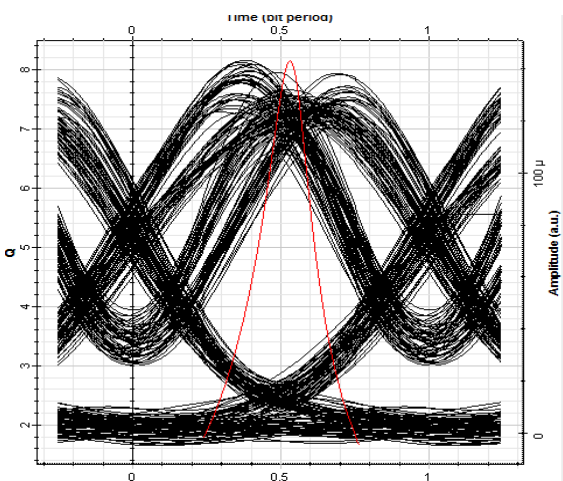

Fig 4 showing Q factor vs. Channel Spacing graph for various modulation formats

IV. EYE DIAGRAMS OF MDRZ



(a) MDRZ at 10dBm Power



(b) MDRZ at 90Km Distance

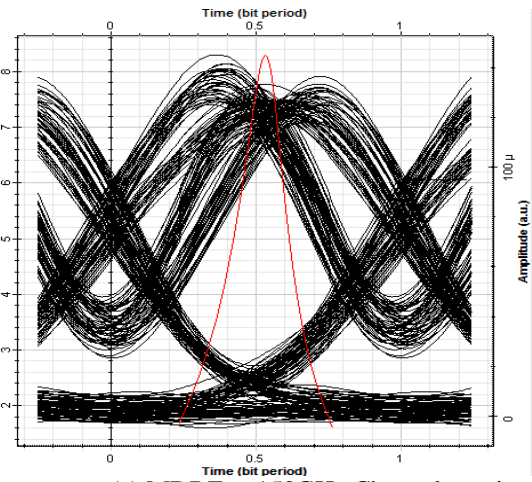

(c) MDRZ at 150GHz Channel spacing

Fig.(a),(b) and (c) showing eye diagrams of MDRZ format for 10dBm Power, 90km Distance and 150GHz spacing resp.

V. CONCLUSION

WDM-PON is innovative technology because it offers efficient bandwidth as per the need of user's requirement. It is also considered as green technology because it reduces the cost of PON network as well as its implementation, operation and maintenance. In this research a WDM-PON system is designed, implemented and tested using Optisystem 14.1. In this paper, we have simulated the 8 channel Bidirectional WDM PON system by changing the values of input power from 0dbm to 20dbm and the fiber distance from 50km to 110km and Channel Spacing from 25GHz to 200GHz by keeping the value of data rate 40 Gbps. It is concluded that at 10dBm power, 150GHz channel spacing and at distance up to 100km MDRZ shows the better performance as compared to other modulation formats. At higher power up to 20dBm CSRZ shows good results which means MDRZ is affected by non-linearity at higher power. The system produces the optimized results over a distance of 100kms. In future combination of TDM and WDM will be produced the best results over long distance communication with 16 channels.

REFERENCES

- [1] Kani J, "Next Generation PON Part 1: Technology Roadmap And General Requirements", IEEE Communications Magazine, vol 46, pp 26- 34, Jan 2008
- [2] Lee C, Sorin W, Kim B, "Fiber To The Home Using A PON Infrastructure" Journal of Lightwave Technology, vol 24, pp 24-12, May 2006.
- [3] John S. Vardakas, Ioannis D. Moscholios, Michael D. Logothetis, Vassilios G.Stylianakis, "An analytical approach for dynamic wavelength allocation in WDM-TDMA PONs servicing ON-OFF traffic", Journal of Optical Communication Network, vol 3, pp 347-358, April 2011.
- [4] Marilet DeAndrade, Anna Buttaboni, Massimo Tornatore and Pierpaolo Boffi, "Optimization of long-reach TDM/WDM

passive optical networks” Elsevier Optical Switching and Networking, vol 16, pp 36–45, June 2015.

- [5] Jan Latal, Jan Vitasek, Petr Koudelka, Petr Siska , “Simulation of Modulation Formats for Optical Access Network Based on WDM-PON”, International Conference on Transparent Optical Networks (ICTON), Graz, Austria, July 6-10, 2014.
- [6] Divya Sharma and Y. K. Prajapati. “Performance Analysis of DWDM System for Different Modulation Schemes Using Variations in Channel Spacing”, Journal of Optical Communication, DOI 10.1515/joc-2016-0011, Feb 2016