

# Optimization of Geometry of Microfabricated Piezoelectric Actuator

Souvik Sutradhar

Department of Instrumentation and Control Engineering, SRM University  
Kattankulathur, Chennai, India

**Abstract**— This paper focuses on optimization of the geometry of piezoelectric actuator for maximization of output for applications such as micro-pump. The device structure consists of a piezoelectric disk/plate which is glued on the top of a silicon plate. Under various constraints the displacement or deflection of the silicon plate attached to the piezoelectric material plate is obtained from simulation and used for the analysis. For analysis purpose a circular and a square shaped silicon plate/membrane has been taken separately into consideration which are simulated under various size, shape and input excitations and the results are compared to determine the optimum dimension. For a 5 mm diameter/edge length silicon plate, the optimum diameter of circular PZT plate obtained is 4.6 mm, whereas, it is 4.1 mm edge length for square PZT plate.

**Keywords**— PZT, plate, displacement, actuator.

## I. INTRODUCTION

Piezoelectric effect was discovered in 1880 by Pierre Curie in quartz crystals. The word 'piezo' originated from the Greek word 'piezen' which means 'to press'. Piezoelectric (PZT) materials when subjected to mechanical pressure produces electricity which is called piezoelectric effect, whereas mechanical deformation caused by application of electric potential across such materials is called inverse piezoelectric effect. This principle of inverse piezoelectric effect is used in PZT actuators for various applications. Piezoelectric actuation has stable driving compared with other actuations. MEMS (Micro-electro-mechanical Systems) technology is used in fabricating such piezoelectric actuators as it results in miniaturization, low power consumption and low expense when produced in bulk. Micropump is one of the most important devices where piezoelectric actuator is used for controlled drug delivery. The oscillation of membrane excited by the piezoelectric actuators attached to it propels the drug flow. Hence analysis of the shape, size and material of the membrane as well as the PZT plate/disk is necessary in order to achieve high and desired performance. In order to obtain optimum geometry, the thickness of the plate/disk has been of major area of interest because a thicker plate would result in a reduced displacement which may result in less force to drive the liquid in micropump, whereas a much thinner plate may result in mechanical damage at increased potential. Apart from the thickness, the edge length or diameter of the plate plays a major role in determining the efficiency of the PZT actuator. Hence, these parameters have been thoroughly analyzed in this paper to obtain maximum output for optimum geometry. The choice of material of the structure also adds to

the maximization of the output. Silicon as a mechanical material is the favorite choice for most people as it has high tensile strength and Young's modulus which makes it the most useful material for mechanical devices. There is wide range of PZT materials such as quartz, barium titanate, PZT-5A, PZT-5H which has its own advantages. PZT-5H (Lead Zirconate Titanate) offers high sensitivity and good response. Analytical expressions for plate deflection in terms of maximum displacement are presented for a set of plate boundary conditions.

## II. DEVICE DESCRIPTION

The PZT actuator has basically three layers, stacked and glued as shown in fig. 1 below [4].

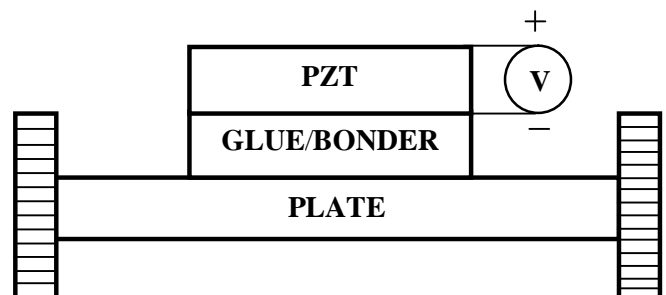

Fig. 1 Schematic model of piezoelectric actuator

The silicon plate of the PZT actuator model is clamped at its circumference/edges. This layer can be termed as the interactive layer as this layer directly interacts with the fluid flow (in case of micropump). On the top of the silicon plate is the PZT layer made of PZT-5H (Lead Zirconate Titanate) glued by an intermediate layer of epoxy. The top two layers are free at its circumference. When an electric potential is applied to the PZT plate, the strain produced in the PZT plate causes it to expand or contract, resulting in actuation. The actuation does not only depends on the shape and size of the silicon plate, but also on the excitation voltage. The PZT material considered in this paper is polarized along z-axis. The different material properties [4] have been listed below. There are two particular shapes of the silicon membrane that has been analyzed here, namely, circular and square which in turn determines the shape of the actuator.

TABLE I  
MATERIAL PROPERTIES OF DIFFERENT LAYERS OF THE DEVICE

Material	Properties	Values
PZT-5H	Piezoelectricity [C/m <sup>2</sup> ]	$\begin{bmatrix} 0 & 0 & -6.62 \\ 0 & 0 & -6.62 \\ 0 & 0 & 23.24 \\ 0 & 0 & 0 \\ 0 & 17.03 & 0 \\ 17.03 & 0 & 0 \end{bmatrix}$
	Relative permittivity	$\begin{bmatrix} 3130 & 0 & 0 \\ 0 & 3130 & 0 \\ 0 & 0 & 3400 \end{bmatrix}$
	Compliance [m <sup>2</sup> /N]	$\begin{bmatrix} 16.5 & -4.78 & -8.45 & 0 & 0 & 0 \\ -4.78 & 16.5 & -8.45 & 0 & 0 & 0 \\ -8.45 & -8.45 & 20.7 & 0 & 0 & 0 \\ 0 & 0 & 0 & 43.5 & 0 & 0 \\ 0 & 0 & 0 & 0 & 43.5 & 0 \\ 0 & 0 & 0 & 0 & 0 & 42.6 \end{bmatrix} \times 10^{-12}$
Epoxy (glue/bonder)	Young's modulus [GPa]	5.17
	Poisson's ratio	0.30
Silicon (plate)	Young's modulus [GPa]	169
	Poisson's ratio	0.29

III. ANALYSIS OF THE SILICON MEMBRANE

A. Governing Equations

The maximum displacement/deflection determines the performance of an actuator. So, analysis of maximum displacement is of high importance while designing an actuator. For a clamped plate, laterally and uniformly loaded, the maximum displacement is at the centre of the plate.

1) *Circular Plate:* The maximum displacement [1] is given by,

$$W_{max\_c} = Pa^4/64D \tag{1}$$

Where,

P = pressure applied  
a = radius of the plate  
D = flexural rigidity and is given by,

$$D = Et^3/12(1- \nu^2) \tag{2}$$

Where,

E = Young's Modulus of the plate material  
t<sup>3</sup> = plate thickness

$\nu$  = Poisson's ratio of the plate material

This flexural rigidity is a measure of stiffness of the plate.

2) *Square Plate:* The maximum displacement [1] is given by,

$$W_{max\_s} = 0.00126Pa^4/D \tag{3}$$

Where,

P = pressure applied  
a = edge length of the plate  
D = flexural rigidity

B. Simulation Results

The circular and square plate having various dimensions is simulated under a fixed load on top surface and the results are plotted as shown below.

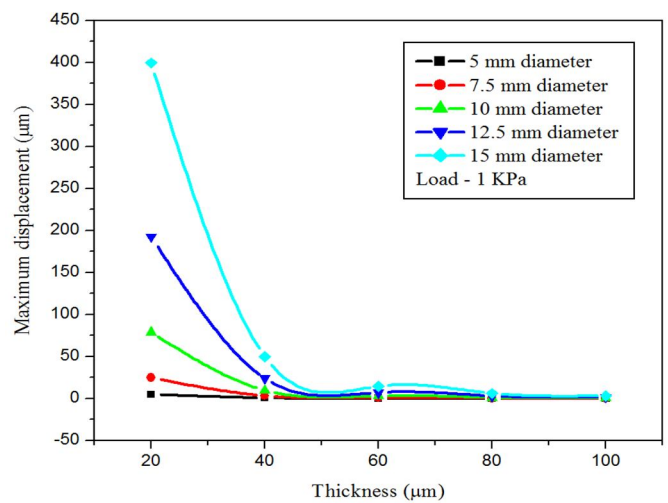

(a)

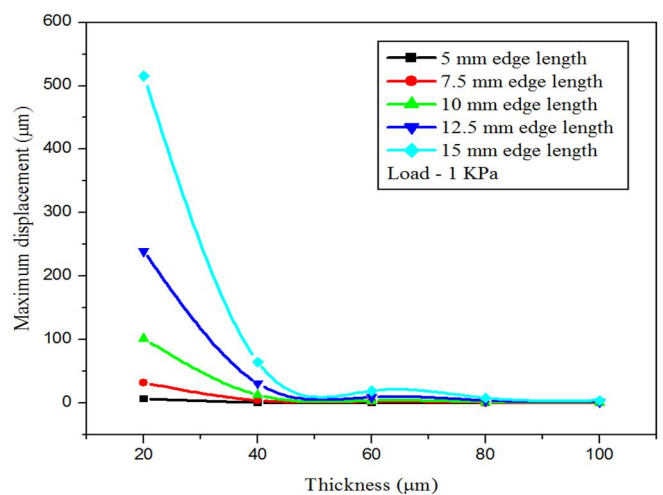

(b)

Fig. 2 Maximum displacement vs. thickness characteristics of (a) circular plate (b) square plate

The above two plots, i.e., fig 2 reveal that as the thickness of the plate is increased, the maximum displacement decreases for various diameter/edge length of the plate. From fig. 3 below [2] [3], it is evident that the centerline displacement decreases with increase in thickness of the plates for any particular diameter/edge length. When the thickness is doubled, the maximum deflection reduces by eight times which is also evident from the equations.

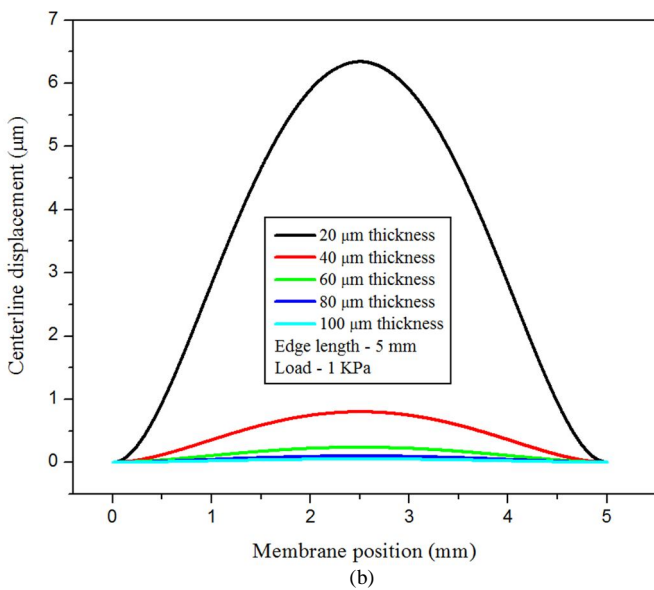
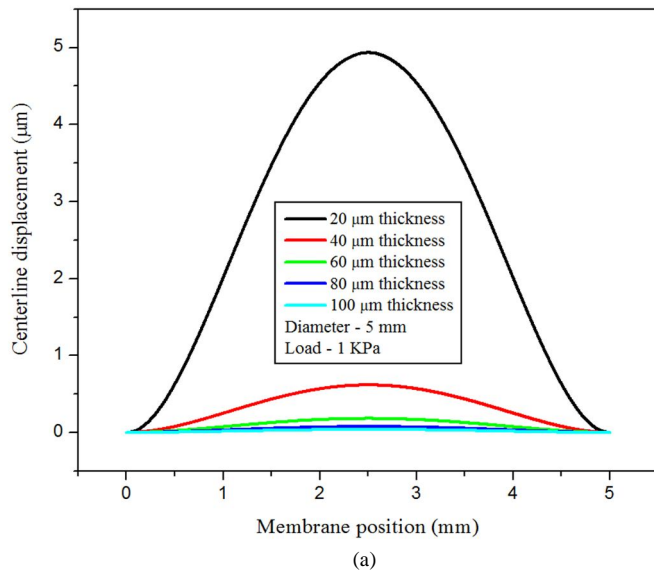

Fig. 3 Centerline displacement vs. membrane position characteristics of (a) circular plate (b) square plate

The following two plots show that as the diameter of circular plate or the edge length of square plate is increased, the maximum displacement also increases proportionally as shown in fig. 4. Apart from this, the graph also indicates that

the maximum displacement decreases with increase in thickness of the plate.

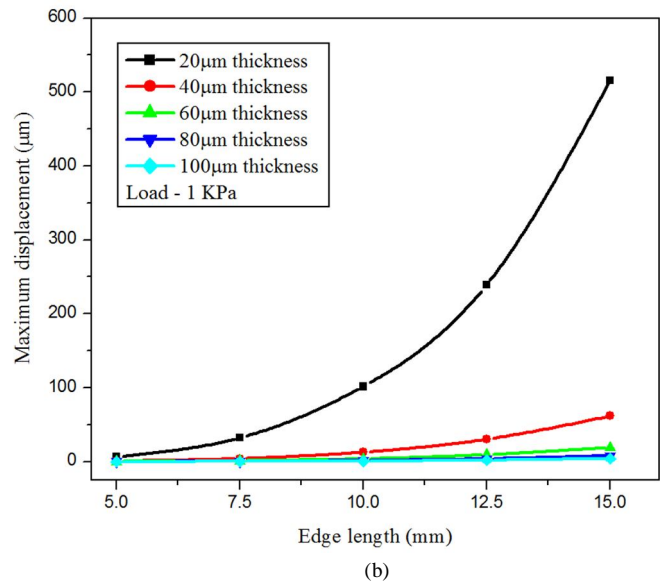
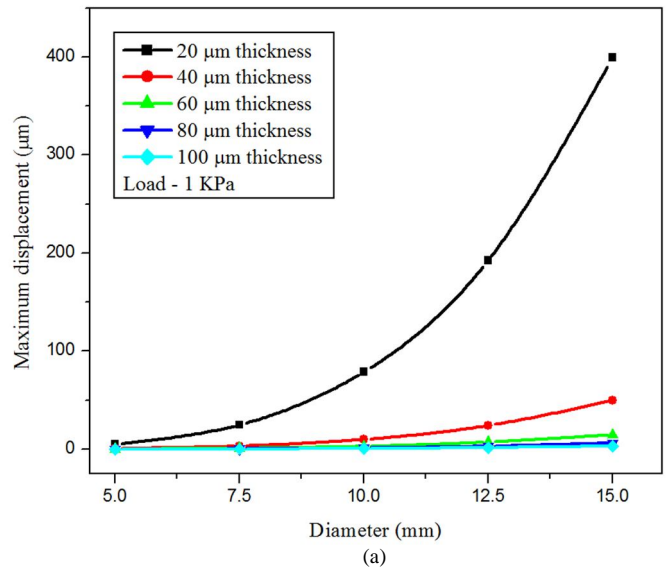

Fig. 4 Maximum displacement vs. diameter/edge length characteristics of (a) circular plate (b) square plate

Fig. 3 also shows that the displacement/deflection at the circumference/edges is zero because the plate is clamped at its outer boundary. It is also observed from the plots that for same dimension the displacement of the square plate is always greater than the circular plate because in this case the surface area of the square plate is always greater than the circular plate. The maximum displacement obtained is for a plate thickness of 20 μm which is also rigid enough to sustain the stress generated. Since maximum displacement is of prime importance for an actuator, so the silicon plate with 20 μm is considered for actuator design in this paper.

IV. ANALYSIS OF THE PIEZOELECTRIC ACTUATOR

A. CAD Model of the actuator

The CAD model of circular and square PZT actuator using COMSOL Multiphysics is shown below.

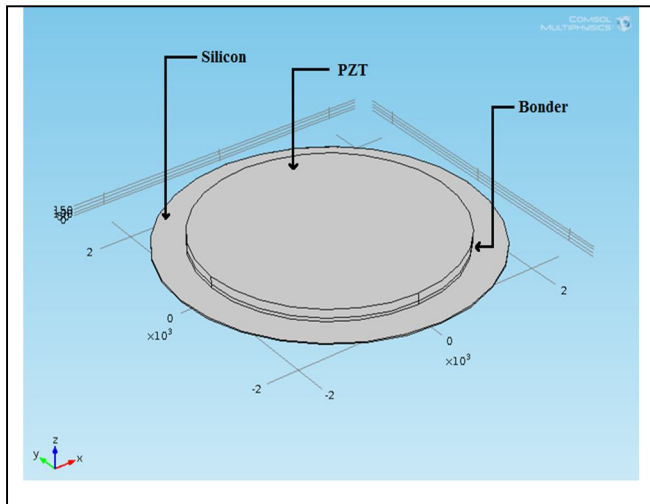

(a)

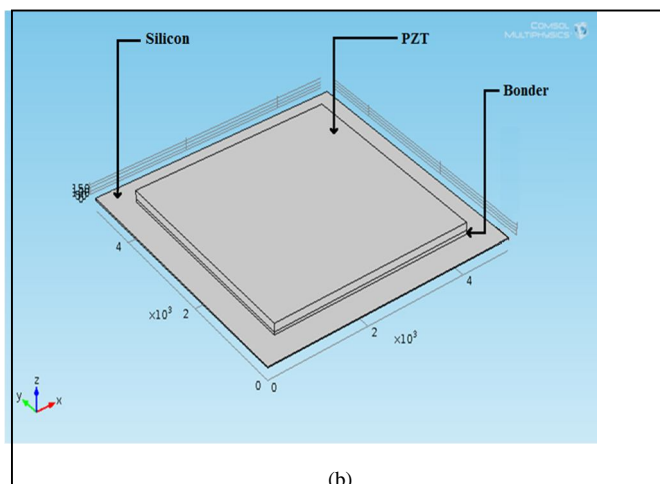

(b)

Fig. 5 CAD model of (a) circular (b) square PZT actuator

In fig. 5 shown above, the silicon plate is under fixed constraint (clamped at its boundary), whereas the other two layers are free. These PZT models (circular and square) as per the schematic model of fig. 1 are simulated subject to a constraint of 100 volt electric potential using different dimensions shown in Table II. The thicknesses of the different layers have been kept constant while the diameter or the edge length has been varied. The dimension of the glue/bonder is varied equally with that of the PZT layer. The ratio of diameter or edge length, being calculated, is an important parameter which aids in determining the optimum dimension.

TABLE II

DIMENSION OF DIFFERENT LAYERS OF PIEZOELECTRIC ACTUATOR

Material	Diameter / Edge length (mm)	Thickness ( $\mu\text{m}$ )
PZT-5H	2.5, 3, 3.5, 4, 4.5, 5	127
Epoxy	2.5, 3, 3.5, 4, 4.5, 5	50
Silicon	5	20

B. Simulation Results

1) *Circular PZT Actuator*: Fig. 6 shows [5] the plot of maximum displacement of the circular PZT actuator vs. the ratio of diameter between PZT disk (d) and silicon disk (D). It can be seen that the maximum displacement at first increases almost smoothly and then after a certain point (optimum value of ratio of diameter) the value tends to fall.

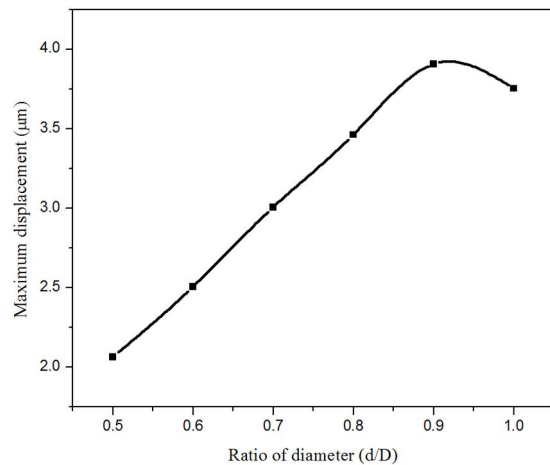

Fig. 6 Maximum displacement vs. ratio of diameter characteristic of circular PZT actuator

Peak value of ratio of diameter (from the plot):

$$d/D = 0.92$$

Where,

d = diameter of the PZT disk

D = diameter of the silicon disk = 5 mm

$$\text{Or, } d = 0.92 * 5 \text{ mm}$$

$$\text{Or, } d = 4.6 \text{ mm}$$

Hence, optimum diameter of the circular PZT disk is 4.6 mm for obtaining maximum displacement for a 5 mm diameter silicon disk. The maximum displacement obtained after simulation is 3.9069  $\mu\text{m}$ . With the above obtained PZT diameter, the following plot is obtained for various potential applied across the PZT layer.

Or,  $l = 4.1 \text{ mm}$

Hence, optimum edge length of the PZT plate should be 4.1 mm for obtaining maximum displacement for a 5 mm edge length silicon plate. The maximum displacement obtained after simulation is  $4.3235 \mu\text{m}$ . With the above obtained PZT edge length, the following plot is obtained for various potential applied across the PZT layer.

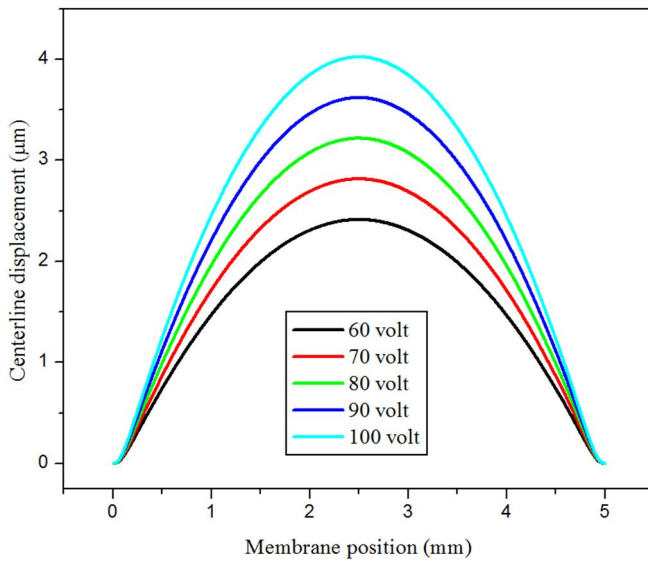

Fig. 7 Centerline displacement vs. membrane position characteristics of circular PZT actuator for various voltages

2) *Square PZT Actuator*: Fig. 8 below shows the plot of maximum displacement of the square PZT actuator vs. ratio of edge length between PZT plate ( $l$ ) and silicon plate ( $L$ ).

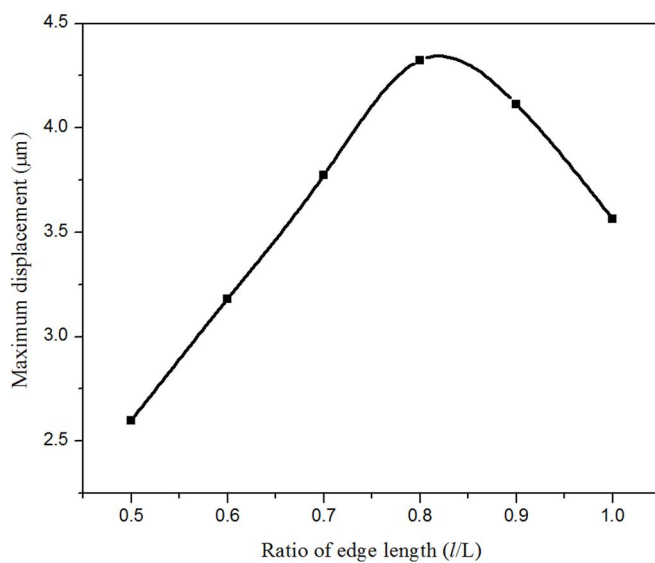

Fig. 8 Maximum displacement vs. ratio of edge length characteristic of square PZT actuator

Peak value of ratio of edge length (from the plot):

$$l/L = 0.82$$

Where,

$l$  = edge length of the PZT plate

$L$  = edge length of the silicon plate = 5 mm

$$\text{Or, } l = 0.82 * 5 \text{ mm}$$

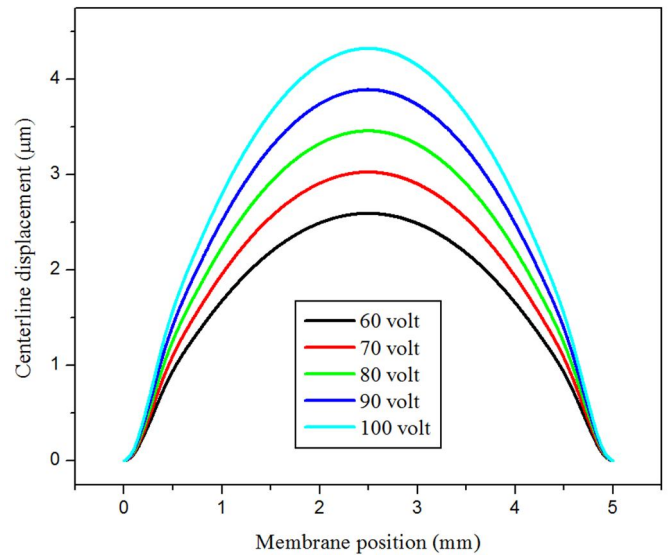

Fig. 9 Centerline displacement vs. membrane position characteristics of square PZT actuator for various voltages

Fig. 7 and fig. 9 certainly shows that the displacement increases proportionally with increase in electric potential. It should be taken care that an optimum value of potential is maintained so that the membrane structure is not affected.

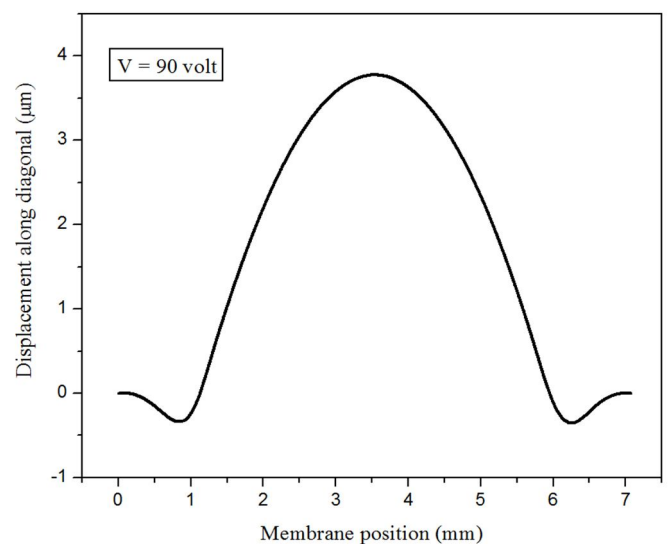

Fig. 10 Displacement along diagonal vs. membrane position characteristic of square PZT actuator

Fig. 10 (above) reveals an interesting fact of square PZT actuator. The structure is simulated with optimum dimensions obtained above, with an electric potential of 90 volt as a constraint. It is seen that near the extremes of the diagonal the deformation is in the opposite direction. This is due to the fact that when the PZT layer actuates in the downward direction (negative z-axis), as per fig. 5, then the stress generated at the corners of it causes the silicon plate to deform on the reverse direction along the extreme diagonal ends.

The sensitivity of the PZT actuator can be easily found in terms of maximum displacement when the input excitation is a dc potential. The sensitivity is 0.040218  $\mu\text{m}/\text{V}$  for a circular PZT actuator whereas it is 0.043236  $\mu\text{m}/\text{V}$  for a square PZT actuator as obtained from fig. 7 and fig. 9 respectively. This sensitivity in terms of maximum displacement is found to be same in both the cases if a sinusoidal signal of 50 Hz frequency is used as the input excitation of the actuator.

#### V. CONCLUSIONS

We can easily observe that while the displacement of the square PZT actuator is more for same dimension but for same surface area of the silicon plate, circular PZT actuator proves to be more efficient in terms of maximum displacement. This can be proved from the governing equations also. One major concern of the square PZT actuator is that the corners along the diagonal get deformed in the reverse direction. But, the sensitivity of square PZT actuator is more than the circular PZT actuator for same dimension which results in high displacement for a certain voltage.

#### ACKNOWLEDGMENT

The author would like to acknowledge the faculties of Instrumentation and Control Engineering department of SRM University for their support in fulfillment of the project.

#### REFERENCES

- [1] S. Timoshenko and S. Woinosky-Krieger, *Theory of Plates and Shells*, Tata McGraw Hill Edition 2010.
- [2] Heiko Fettig and James Wylde, *Thermo-Mechanical Analysis of a Multi-Layer MEMS Membrane*, Nortel Networks - Optical Components, 2002.
- [3] Qifeng Cui, Chengliang Liu and Xuan F. Zha, *Study on a piezoelectric micropump for the controlled drug delivery system*, 2007.
- [4] Il-Han Hwang, Sung-Kil Lee, Sang-Mo Shin, Yong-Gu Lee, Jong-Hyun Lee, *Flow characterization of valveless micropump using driving equivalent moment: theory and experiments*, 2008.
- [5] Baowei Wang, Xiangcheng Chu, Enzhu Li, Longtu Li, *Simulations and analysis of a piezoelectric micropump*, June 2006.