

# SC-FDMA & OFDMA in LTE physical layer

Murtadha Ali Nsaif Sukar<sup>#1</sup> and Maninder Pal<sup>\*2</sup>

<sup>#1</sup>M.Tech Scholar, Department of Electronics & Communication Engineering, Maharishi Markandeshwar University, Mullana, Ambala, Haryana, INDIA

<sup>\*2</sup>Research Associate, NIBEC, University of Ulster, Jordanstown, Northern Ireland, UK

**Abstract**— This paper provides the introduction of LTE and the key components of its physical layer. These descriptions are simplified version of the detailed descriptions provided by 3gpp. In LTE, the OFDMA is used as downlink and SCFDMA as uplink modulation schemes; with OFDM as the basic building block. OFDMA is used for achieving high spectral efficiency in communication system; whereas, SC-FDMA for uplink multiple access scheme in LTE system. This paper evaluates the performance of SC-FDMA and OFDMA of LTE physical layer by considering different modulation schemes (BPSK, QPSK, 16QAM and 64QAM) on the basis of PAPR, BER and error probability. From the simulated results, it is observed that for a particular value of SNR, the BER increases for high order modulation (16-QAM and 64-QAM) in both OFDMA and SC-FDMA. However, the lower order modulation schemes (BPSK and QPSK) experience less BER at receiver; thus lower order modulations improve the system performance in terms of BER and SNR. In terms of bandwidth efficiency, the higher order modulation accommodates more data within a given bandwidth and is more bandwidth efficient as compared to lower order modulation. Thus, there exists a tradeoff between BER and bandwidth efficiency among these modulation schemes used in LTE. It is also observed that the error probability increases as order of modulation scheme increases. Therefore, the selection of modulation schemes in adaptive modulation is quite crucial based on these results.

**Keywords** - OFDMA; SC-FDMA; LTE; BER and PAPR.

## I. INTRODUCTION OF LTE SYSTEMS

Long Term Evolution (LTE) is the result of the standardization work done by 3GPP to achieve a high speed radio access in mobile communications. 3GPP is a collaboration of groups of telecom associations working on Global System for Mobile Communication (GSM) [1-10]. 3GPP published and introduced the various standards for LTE in Release 8 in 2008. In 2010, the Release 9 was introduced to provide enhancements to LTE. In 2011, its Release 10 was brought as LTE-Advanced, to expand the limits and features of Release 8 and to meet the requirements of the *International Mobile Telecommunications Advanced* (IMT-Advanced) for the fourth generation (4G) of mobile technologies [1-10]. LTE radio transmission and reception specifications are documented in TS 36.101 for the user equipment (UE) and TS 36.104 for the eNB (Evolved Node B). As per these specifications, LTE is theoretically capable of supporting up to 1 Giga Bits per second (1 Gbps) for fixed user and up to 100 Mega Bits per second (100 Mbps) for high speed user. This is considerably high speed. For this reason, both research and industrial communities are making considerable efforts

on the study of LTE systems, proposing new and innovative solutions in order to analyse and improve their performance.

The LTE radio access network architecture is shown in Figure 1. LTE encompasses the evolution of the radio access network through the Evolved Universal Terrestrial Radio Access Network (EUTRAN). LTE is accompanied by an evolution of the non-radio aspects under the name ‘System Architecture Evolution’ (SAE) which includes the Evolved Packet Core (EPC) network. Together LTE & SAE comprise the Evolved Packet System (EPS).

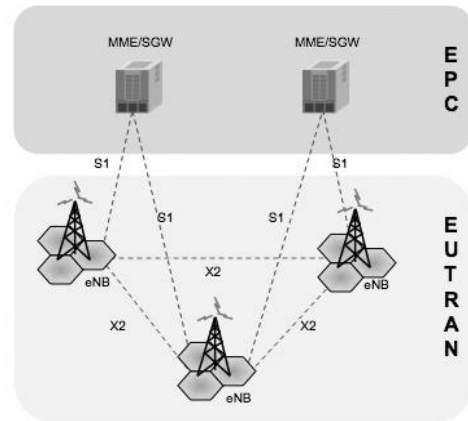

Fig 1: LTE radio access network architecture [2].

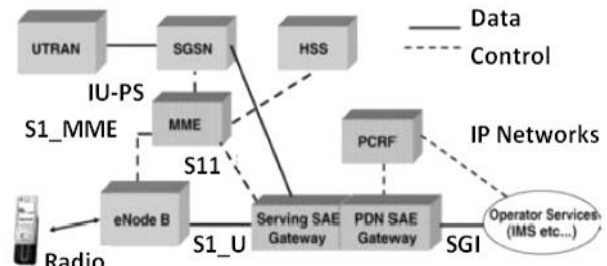

Fig 2: LTE /SAE architecture [2].

In Figure 2, EPS uses the concept of EPS bearers to route IP traffic from a gateway in Packet Data Network (PDN) to the UE. A bearer is an IP packet flow with a defined Quality of Service (QoS) between the gateway and UE. The E-UTRAN with EPC together set up and release bearers as required by applications. The eNodeB is responsible for Radio Resource Management (RRM) – assignment, reassignment and release of radio resources. It is used in the signaling of access stratum signaling protocols, along with scheduling and transmission of paging messages received from the Mobility Management Entity (MME) and broadcast information received from the

MME. Other functions such as measurement gathering for scheduling, mobility decisions and routing the user plane data to Serving Gateway (SGW) are also taken care by the eNodeB.

MME also helps authenticate UEs into the system, tracks active and idle UEs and pages UEs when triggered by the arrival of new data. In Figure 2, when a UE attaches to an eNB, the eNB selects an MME. MME in turn selects the Serving Gateway (SGW) and the Packet Data Network Gateway (P-GW) that handles the user’s bearer packets. MME also takes care of the non-access stratum signaling and authentication (in conjunction with the home subscriber server-HSS). The S-GW also maintains a buffer for each idle UE and holds the packets until the UE is paged and an RF channel is re-established. Other functions of the S-GW include IP backhaul admission and congestion control, point of policy enforcement and IP backhaul Quality of Service (QoS). Packet gateway is responsible for the UE Internet Protocol address assignment and provides connectivity to the external packet data networks. The P-GW provides charging (billing) support, packet filtering/screening, policy enforcement and lawful intercept. If a UE is accessing multiple packet data networks, it may have connectivity to more than 1 P-GW. Home subscriber server (HSS) is the master database that contains the UE profiles and authentication data used by the MME for authenticating and authorizing UEs. It also stores the location information of the UE which is used for user mobility and inter-technology handovers. The HSS communicates with the MME using diameter protocol. Policy and Charging Rules Function (PCRF), shown in Figure 2, create rules for setting policy and charging rules for the UE. It provides network control for service data flow detection, gating, QoS authorization and flow based charging. It applies security procedures, as required by the operator, before accepting service information. Serving GPRS (General Packet Radio System) Support Node (SGSN) is responsible for the delivery of data packets to and from UEs within its geographical service area. The SGSN provides the interfaces between the MME and S-GW in the EPC [2]. In physical layer, the technologies used to implement these components of LTE are Orthogonal Frequency Division Multiple Access (OFDMA) in downlink (DL) and Single Carrier Frequency Division Multiple Access (SC-FDMA) for uplink (UL), as shown in Figure 3.

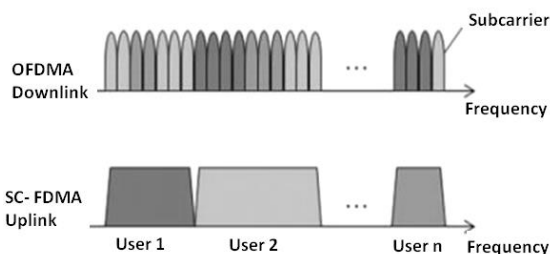

Fig 3: OFDMA and SC-FDMA in LTE [3].

The detailed specification of LTE is given in Table 1; whereas, the comparison of LTE with its 3G predecessors is shown in Table 2.

Table 1: Specification of LTE [1-3].

Specification	Details
Peak downlink speed 64QAM (Mbps)	100 (SISO), 172 (2x2 MIMO), 326 (4x4 MIMO)
Peak uplink speed (Mbps)	50 (QPSK), 57 (16QAM), 86 (64QAM)
Data type	All packet switched data (voice and data). No circuit switched.
Channel bandwidths	1.4, 3, 5, 10, 15 and 20 MHz
Duplex schemes	FDD and TDD
Latency	Idle to active less than 100 ms; and small packets ~10 ms
Spectral efficiency	Downlink: 3 to 4 x HSDPA Rel. 6 Uplink: 2 to 3 x HSUPA Rel. 6
Supported antenna configurations	Downlink: 4x2, 2x2, 1x2, 1x1 Uplink: 1x2, 1x1
Access schemes	OFDMA (downlink) & SC-FDMA (uplink)
Modulation types	QPSK, 16QAM, 64QAM (Uplink and downlink)
Coverage	Full performance up to 5 Km, Slight degradation (5 – 30) Km

Table 2: Comparison of UMTS, HSPA, HSPA+ and LTE [1-10].

PARAMETERS	WCDMA (UMTS)	HSPA HSDPA/ HSUPA	HSPA+	LTE
Max downlink speed	384Kbps	14Mbps	28Mbps	100Mbps
Max uplink speed	128Kbps	5.7Mbps	11Mbps	50Mbps
Latency round trip time	150ms	100ms	50ms (max)	~10ms
3GPP releases	Rel 99/4	Rel 5/6	Rel 7	Rel 8/10
Approx years of initial roll out	2003/04	2005/06 (HSDPA) 2007/08 (HSUPA)	2008/09	2009/10
Access technology	CDMA	CDMA	CDMA	OFDMA/ SC-FDMA

The latest version, i.e., LTE-Advanced (LTE-A) extends further the features of LTE in order to exceed or at least meet the IMT-Advanced requirements. It has the potential of offering the high speed of 1Gps downlink and 500Mbps uplink, with a DL transmission band of 100MHz and UL transmission band of 40MHz and scalable bandwidths upto 20 to 100MHz. This paper presents the description of the physical layer of LTE.

## II. LTE PHYSICAL LAYER DESCRIPTION

In LTE physical layer, the LTE frame structure is of two types:

1. *Type-1 LTE Frequency Division Duplex (FDD) mode systems:* Type-1 frame structure works on both half duplex and full duplex FDD modes. This type of radio frame has duration of 10ms and consists of 20 slots, with each slot having equal duration of 0.5ms [9]. A sub-frame consists of two slots; therefore, one radio frame has 10 sub-frames as shown in Figure 4. In FDD mode, downlink and uplink transmission is divided in frequency domain; such that, half of the total sub-frames are used for downlink and half for uplink, in each radio frame interval of 10ms.

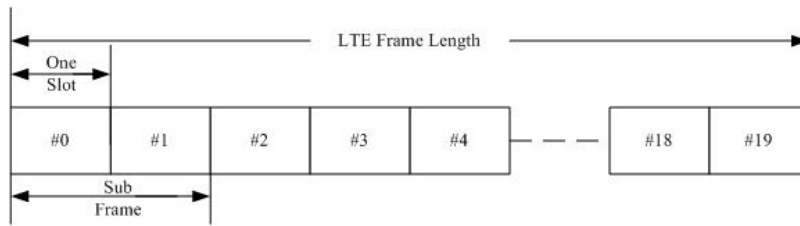

Fig 4: LTE Type-1 frame structure [7].

2. *Type-2 LTE Time Division Duplex (TDD) mode systems:* Type-2 frame structure comprises two identical half frames of 5ms duration each. Both half frames have further 5 sub-frames of 1ms duration as illustrated in Figure 5. In Figure 5, one sub-frame consists of two slots and each slot has duration of 0.5ms. There are some special sub-frames which consist of three fields: Guard Period (GP), Downlink Pilot Timeslot (DwPTS) and Uplink Pilot Timeslot (UpPTS). In terms of length, these

three fields are configurable individually, but each sub-frame must have total length of 1ms, as per specifications of LTE. There are seven uplink/downlink configurations used for either 5ms or 10ms switch-point periodicities. A special sub-frame exists in both half frames in case of 5ms switch-point periodicity; whereas, for 10ms switch-point periodicity, the special frame exists only in the first half-frame.

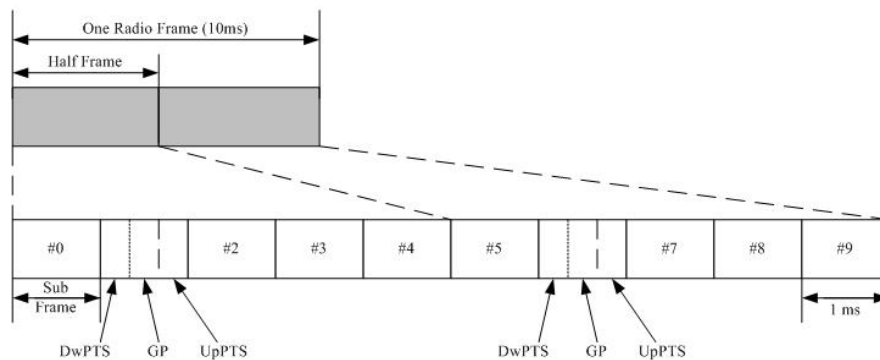

Fig 5: LTE Type-2 frame structure [7].

The other key components/elements of LTE and their roles are described below.

**A) LTE resource block:** In LTE, the time and frequency resources of the available bandwidth are divided into smaller blocks to support multiuser configuration and improve overall system efficiency. As LTE downlink uses OFDMA and uplink supports SC-OFDMA, the available bandwidth is divided into number of orthogonal frequencies with a spacing of  $\Delta f = 15\text{KHz}$  called subcarriers [8]. This subcarrier spacing of 15 KHz helps keeping Inter Carrier Interference (ICI) to the lower level even the mobile user is moving with high

speed and causing high Doppler shifts in the frequency. A resource block (RB) or sub-frame (Figure 6) is formed of a length 1ms using 12 subcarriers and 12 or 14 OFDM symbols (depending on the length of Cyclic Prefix (CP)). Furthermore, the RB is subdivided into two slots of 0.5 ms each containing 6 or 7 OFDM symbols over 12 subcarriers. Such fine granularity of the time and frequency resources helps network to assign one or more RBs to different active users simultaneously depending upon the channel conditions and other factors. These building blocks are grouped together to form the radio resources.

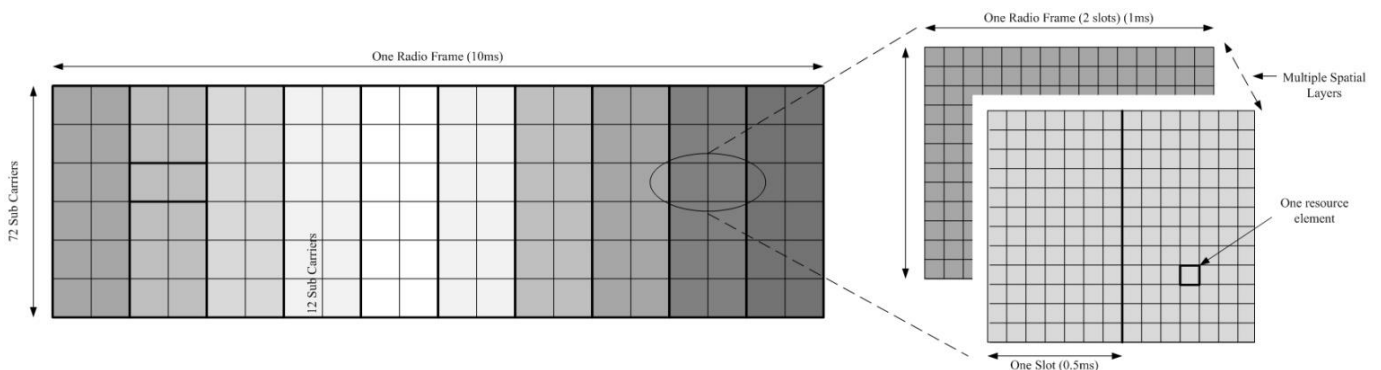

Fig 6: LTE radio frame structure with 72 subcarriers with  $\Delta f = 15\text{KHz}$  [10].

**B) Duplexing modes:** In LTE, two duplexing schemes are available, i.e., time division duplexing (TDD) and frequency division duplexing (FDD). In TDD, the entire frequency

resource (bandwidth) is used to perform two way communications with time resource divided in two directions: one is uplink and other is downlink. Whereas in FDD; the

available bandwidth is partitioned into two sub-frequency bands (pair of bands): one for uplink and the other for downlink. Frame structure for FDD system is just radio frames arranged one after the other in each frequency band. In TDD, the radio frame is divided in two sections, one for uplink and other for downlink data transmission. The number of subframes in a group is varied according to system configuration. In TDD mode, the time resource is multiplexed to transfer data in uplink and downlink direction. This multiplexing of time needs switching of resources and circuits to prepare for downlink and uplink data transfer. This switching takes small finite time in which no data can be transferred in either direction. For this time to accommodate; there is a special frame defined in TDD radio frame. The special frame takes care of propagation delay in both

directions (Uplink and Downlink). The LTE radio frame of length 10ms in TDD carries downlink and uplink data; and also special subframes as shown in Figure 7; and can be divided in two configurations:

- Every 5ms transition between downlink and uplink and
- Every 10ms transition between downlink and uplink.

There are total 7 configurations defined in TDD to support various downlink, uplink data rates and different applications such as Voice over IP (VoIP), real time data transfer and non real time data transfer. These configurations are shown in Figure 7. In LTE, switching time is flexible and can be extended for 1, 2 or 3 OFDM symbols. This flexibility in LTE slightly increases throughput at the expense of negligible overhead.

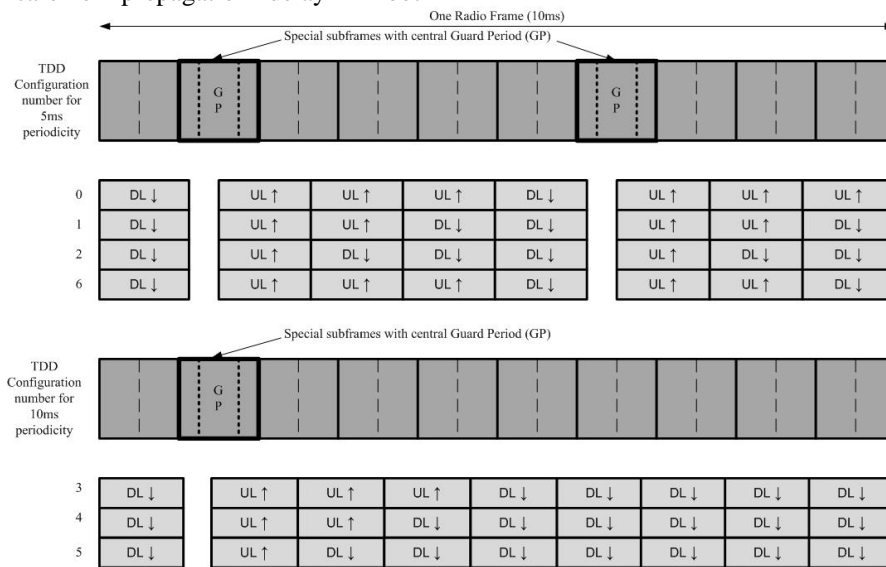

Fig 7: Uplink downlink configurations of 5ms and 10ms periodicity in TDD LTE [10].

**C) LTE physical layer signal generation**

In wireless communication systems, some error usually gets added to the transmitted signal. Because of this error, the reception process may interpret the received data incorrectly. To overcome this issue, LTE signal generation (Figure 8) uses Turbo coding, Tail-Biting convolution coding, Block coding and Repetition coding with various coding rates of 1/3 to 1/16

for different physical channels [12]. As there are many users using the system simultaneously, security of the data and control channels for their data is maintained with the help of scrambling process. Also various data and control channels specific to the eNodeB are scrambled using eNodeB specific codes.

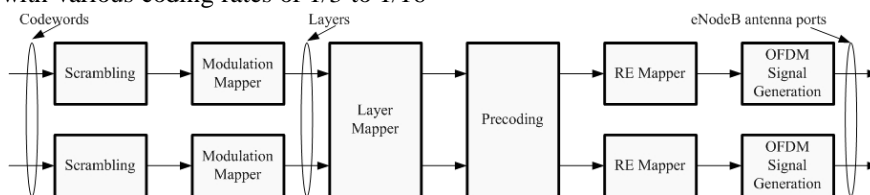

Fig 8: LTE physical layer signal generation procedure block diagram.

**D) Physical Broadcast Channel (PBCH):** When the users try to communicate first time with eNodeB; they have very limited information about the system parameters. Thus, there is a need of some robust and fixed location information block in the frame structure that can provide all necessary information for establishing a connection. In LTE, this is

provided by Physical Broadcast Channel (PBCH) [10]. The PBCH broadcasts a limited number of parameters essential for initial access of the cell such as downlink system bandwidth, the Physical Hybrid ARQ Indicator Channel structure, and initial ranging information. These parameters are carried in a Master Information Block, which is 14 bits long. The PBCH is

designed to be detectable without prior knowledge of system bandwidth and to be accessible at the cell edge. The MIB is coded with convolutional coder at a very low coding rate of 1/3 (effective coding rate is 1/48) and mapped to the 72 center sub-carriers (6RBs) of the OFDM structure. PBCH transmission is spread over four 10 ms radio frames to span a 40 ms period as shown in Figure 9 [10]. Each subframe is self decodable which reduces latency and UE battery drain in case of good signal quality, otherwise, the UE would ‘soft-combine’ multiple transmissions until the PBCH is decoded.

**E) Physical Downlink Shared Channel (PDSCH):** User data is communicated in the downlink on time and frequency resource called as Physical Downlink Shared Channel (PDSCH). PDSCH is the main data carrying channel in LTE which is scheduled to users by eNodeB. This is used in carrying downlink data per Resource Block basis, system

information not carried by PBCH and paging information. The data from higher layer (MAC) comes with periodicity of 1ms, which is subframe duration. This data can be assigned to one subframe or can be divided in to two parts and assigned to the different slots of the different subframes to gain from frequency diversity [12]. If the data is assigned to both the slots in a subframe then it is called localized mapping; and if it is assigned to different slots of different subframe then it is called as distributed mapping of data. Distributed mapping of data achieves gain from the frequency diversity. This means LTE data may be detected in the distributed mapping scheme with low SNR at the UE. The data is modulated using QPSK, 16QAM or 64 QAM adaptively to achieve best system throughput. To guard against propagation channel errors, convolutional turbo coder is used for forward error correction with basic rate of 1/3 [12].

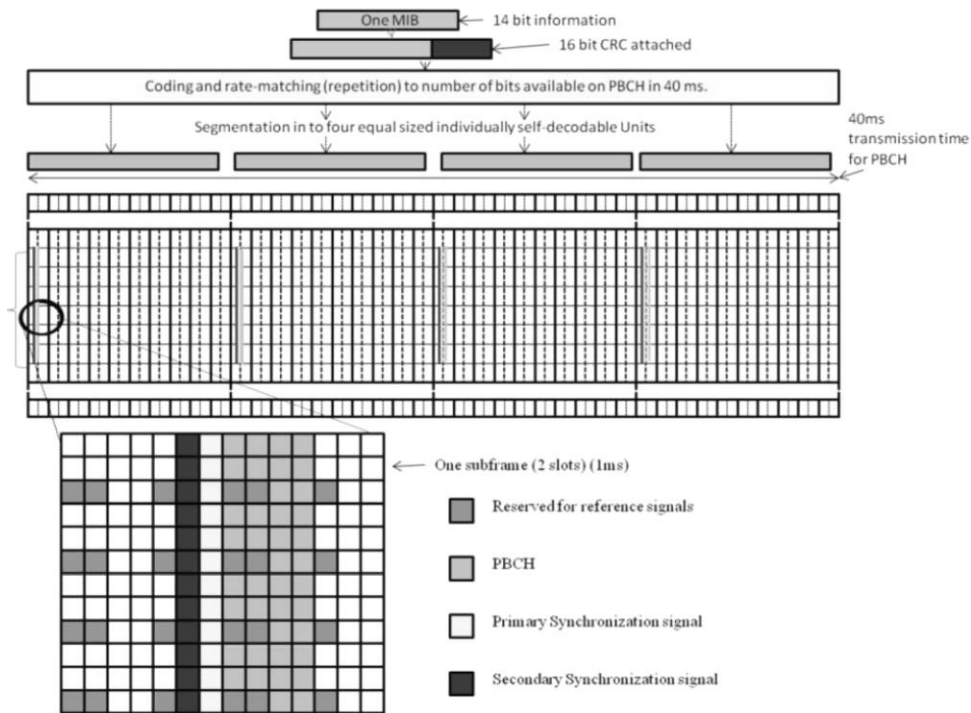

Fig 9: Physical mapping of PBCH [10].

**F) Physical Downlink Control Channel (PDCCH):** The control channels are used to indicate users the place in a time and frequency grid at which their data is placed. The physical mapping in LTE is shown in Figure 10; where, downlink control channel (PDCCH) is assigned to occupy the first 1, 2 or 3 OFDM symbols in a subframe of each subframe, extending over the entire system bandwidth [12]. The information about number of symbols is conveyed by PCFICH. This control channel carries resource allocation information in downlink and uplink which is contained in a Downlink Control Information (DCI) message, ranging control information and Hybrid Automatic Repeat Request (HARQ) information which is nothing but acknowledgements to the UEs indicating packets received by eNodeB. This channel is modulated with QPSK and coded with tail biting convolutional coding with coding rate of 1/3.

**G) Physical Control Format Indicator Channel (PCFICH)** The PCFICH carries a Control Format Indicator (CFI) which indicates the number of OFDM symbols (i.e. normally 1, 2 or 3) used for transmission of control channel information in each subframe. This is done by 4 orthogonal codes assigned for each number of symbols in the control channel. Orthogonal codes are 32 bits and are modulated with QPSK modulation and mapped to the 16 Resource elements at fixed location. The cell specific offset and scrambling sequence is applied to this data to minimize interference from other neighboring cell transmissions [1].

**H) Physical Uplink Control Channel (PUCCH):** This channel transmits uplink control information from UE to eNodeB. The resources required for UE to transmit data to eNodeB are requested on this channel with the help of pre-defined communication protocol. PUCCH also carry other

uplink control messages which include HARQ ACK/NACK, channel quality indicators, MIMO feedback and scheduling requests [10]. PUCCH uses BPSK or QPSK as modulation scheme and block codes or tail biting convolutional codes

with rate of 1/3 as a modulation scheme. These control messages are placed at the edge of the bandwidth to gain frequency diversity as shown in Figure 11.

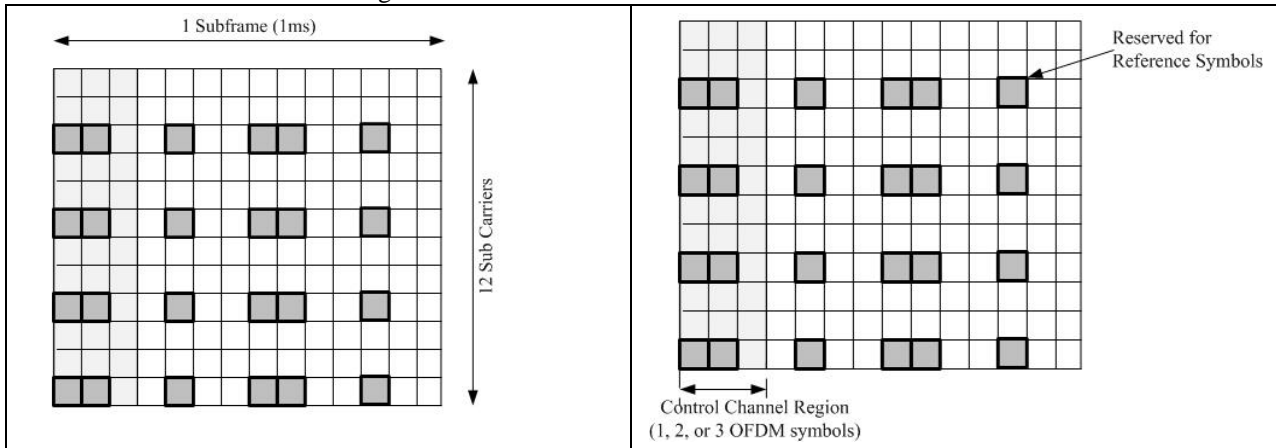

Fig 10: PDCCH physical mapping in the subframe [10].

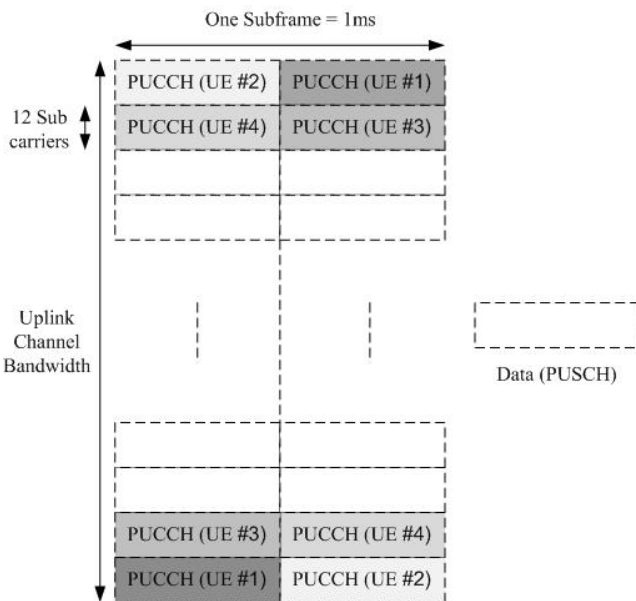

Fig 11: Physical uplink control channel mapping to physical resources [10].

**I) Physical Random Access Channel (PRACH):** User equipments, after having downlink synchronization, also perform uplink synchronization to connect to the eNodeB. This uplink timing and frequency synchronization is done with the help of PRACH. As in downlink synchronization, uplink synchronization is also done with the help of Zadoff Chu (ZC) sequences due to their properties. As the sequence is transmitted from UE with limited battery power, the length of the sequence is increased to increase SINR at the eNodeB. This also helps increasing the coverage of cell. This change in length forces to change the frequency spacing between subcarriers, which is the most important change in the physical layer parameters. To fit the preamble in one subframe length and keep other parameters and data transmissions from

connected users safe, the preamble duration of 800 $\mu$ s with cyclic prefix of 103 $\mu$ s and guard time of 97 $\mu$ s is chosen. This can cover cell radius of 14Km. The PRACH transmission slot consists of 72 sub-carriers in the frequency domain (six Resource Block, 1.08 MHz) as shown in Figure 12 [6].

### III. IMPLEMENTING OFDMA AND SC-FDMA

#### A) OFDMA system as LTE downlink

Due to high spectral efficiency and robust transmission in presence of multipath fading, the OFDMA is used as modulation scheme for downlink in LTE systems. In OFDMA transmitter, the available spectrum is divided into number of orthogonal subcarriers. The subcarrier spacing for LTE system is 15 KHz with 66.67 $\mu$ s OFDMA symbol duration. The high bit-rate data stream passes through modulator, where adaptive modulation schemes such as BPSK, QPSK, 16-QAM and 64-QAM is applied. This multilevel sequence of modulated symbols is converted into parallel frequency components (subcarriers) by serial to parallel converter, as shown in Figure 13. The IFFT stage converts these complex data symbols into time domain and generates OFDM symbols. A guard band is used between OFDMA symbols in order to cancel the Intersymbol Interference at receiver. In LTE, this guard band is called Cyclic Prefix (CP) and the duration of the CP needs to be greater than the channel impulse response or delay spread. The receiver does not deal with the ISI but still have to consider the channel impact for every single subcarrier that have experienced amplitude changes and frequency dependent phase. In LTE, the OFDMA uses two types of CP, i.e, normal CP and extended CP. The normal CP is used for high frequencies (urban areas) and extended CP for lower frequencies (rural areas). At receiver, the CP is first removed and then subcarriers are converted from parallel to serial sequence. The FFT stage further converts the symbols into frequency domain followed by equalizer and demodulation as shown in Figure 13 [7].

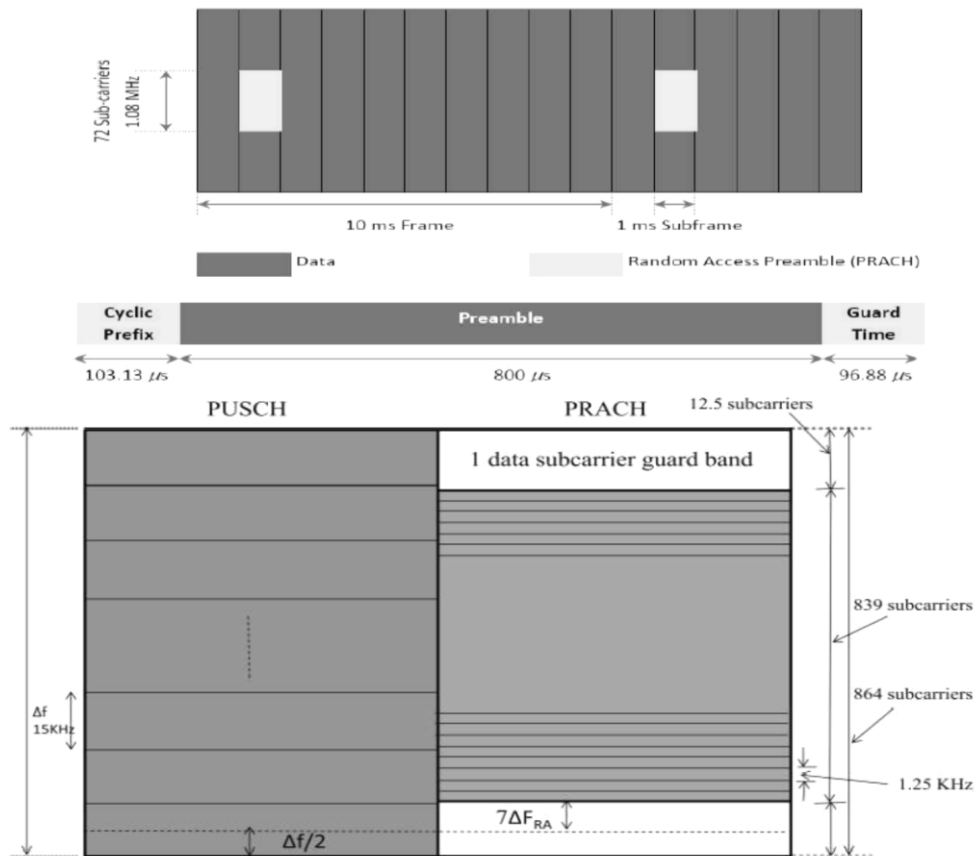

Fig 12: PRACH preamble sequence structure and physical mapping to subcarriers [10].

In order to improve the system capacity, peak data and coverage reliability, the signal transmitted to and by a particular user is modified to account for the signal quality variation through a process commonly referred to as adaptive modulation and coding (AMC). AMC provides the flexibility to match the modulation-coding scheme to the average channel conditions for each other. With AMC, the power of the transmitted signal is held constant over a frame interval, and the modulation and coding format is changed to match the current received signal quality or channel conditions. For example, AMC can employ QPSK for noisy channels and 16 QAM for clearer channels. The former is more robust and can tolerate higher levels of interference but has lower transmission bit rate. The later has twice higher bit rate but is more prone to errors due to interference and noise; thus, it requires stronger forward error correction (FEC) coding which in turn means more redundant bits and lower information bit rate. In downlink, the subcarriers are divided into resource blocks. This allows the system to split the subcarriers into small parts, without mixing the data across the total number of subcarriers for a given bandwidth. The resource block consists of 12 subcarriers for a single time slot of 0.5ms duration. The structure of physical resource block (PRB) is given in Figure 14 [10]. There are different numbers of resource blocks for different signal bandwidths in LTE, as shown in Table 3. The modulation parameters for downlink OFDMA are mentioned in Table 4.

Bandwidth (MHz)	1.4	3	5	10	15	20
PRB Bandwidth (KHz)	180					
Subcarrier Bandwidth (KHz)	15					
Number of Resource Blocks	6	15	25	50	75	100

Table 3: Physical resource blocks for different bandwidths of LTE.

### B) SCFDMA system as LTE uplink

In contrast to OFDMA, the SC-FDMA uses an additional N-point DFT stage at transmitter and an N-point IDFT stage at receiver. The basic block diagram of SC-FDMA transmitter is shown in Figure 15. In SC-FDMA, the data is mapped into signal constellation according to the QPSK, 16-QAM, or 64-QAM modulation, depending upon the channel conditions similarly as in OFDMA. Whereas, the QPSK/QAM symbols do not directly modulate the subcarriers; these symbols pass through a serial to parallel converter followed by a DFT block that produce discrete frequency domain representation of the QPSK/QAM symbols. Pulse shaping is followed by DFT element, but it is optional and sometimes needs to shape the output signal from DFT. If pulse shaping is active then in the actual signal, bandwidth extension occurs. The Discrete Fourier symbols from the output of DFT block are then mapped with the subcarriers in subcarrier mapping block. After mapping the frequency domain; the modulated subcarriers pass through IDFT for time domain conversion. The rest of transmitter operation is similar as OFDMA.

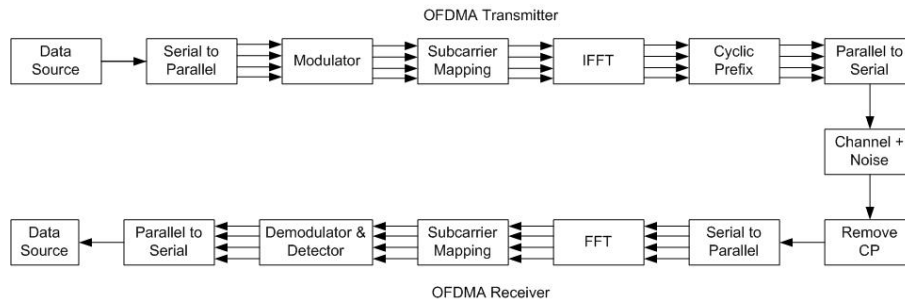

Fig 13: Block diagram of an OFDMA system.

The sub-carrier mapping plays an important role in the transmitter of SC-FDMA. It maps each of the N-DFT output on a single subcarrier out of M subcarriers, where M is the total number of subcarriers for available bandwidth. The subcarrier mapping is achieved by two methods: localized subcarrier mapping and distributed subcarrier mapping. The modulation symbols in localized subcarrier mapping are assigned to M adjacent subcarriers; whereas in distributed mode, the symbols are uniformly spaced across the whole channel bandwidth. Localized subcarrier mapping is also referred as localized SCFDMA (LFDMA); whereas, distributed subcarrier mapping referred as distributed SCFDMA (DFDMA). In transmitter, the IDFT assigns zero amplitude to the unoccupied subcarriers in both modes of subcarrier mapping. The IFDMA is more efficient in SC-FDMA, in a manner that the transmitter can modulate the signal in time domain without using DFT and IDFT. If  $Q = M \times N$  for the distributed mode with equidistance between subcarriers then it is called Interleaved FDMA (IFDMA) [11]. Where, M is number of subcarriers, Q is number of users and N is number of subcarriers allocated per users. In distributed mapping, N-discrete frequency signals are mapped uniformly spaced sub-carriers; whereas in localized mapping, N-discrete frequency signals are mapped on N consecutive subcarriers. The SC-FDMA receiver is very similar to the OFDMA receiver with addition of IDFT despreading block at the output of the IFFT block to undo the transmitter procedures. The received signal is passed through the RF stage. Then CP is removed to mitigate multipath interference. This multipath interference-free symbol is then passed to FFT where the time domain signal is converted to frequency domain signal. De-mapping of the sub-carrier according to localized or

distributed scheme used by the transmitter is done at the subcarrier de-map stage. The next important stage in SC-FDMA is to de-spread the signal using IDFT to convert the data in to symbols and then to original bit stream using detection logic.

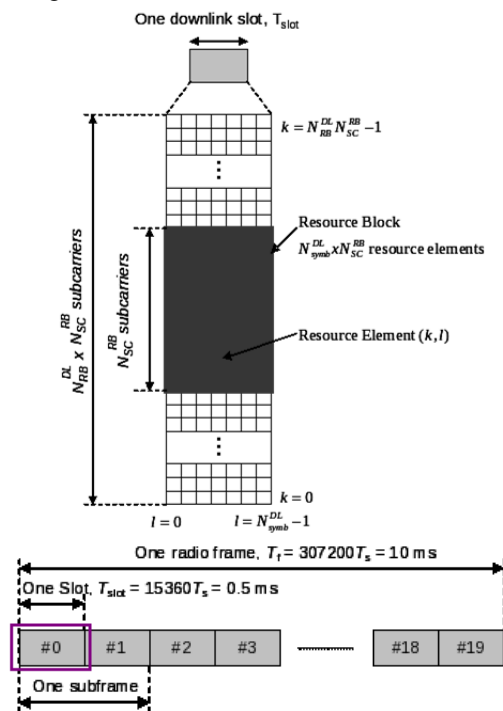

Fig 14: Downlink Physical Resource Block [10].

Table 4: LTE physical layer parameters.

PARAMETERS	VALUES					
Transmission Bandwidth (MHz)	1.25	2.5	5	10	15	20
Sub-carrier spacing	15 KHz					
Sub-frame duration	0.5ms					
Sampling Frequency (MHz)	1.92 (1/2x3.84)	3.84	7.68 (2x3.84)	15.36 (4x3.84)	23.04 (6x3.84)	30.72 (8x3.84)
FFT Size	128	256	512	1024	1536	2048
No. of Occupied Sub-carrier	76	151	301	601	901	1201
CP Lengths (us/sample)	Short					
	(4.69/9) x6 (5.21/10) x1	(4.69/18) x6 (5.21/10) x1	(4.69/36) x6 (5.21/40) x1	(4.69/72) x6 (5.21/80) x1	(4.69/108) x6 (5.21/120) x1	(4.69/144) x6 (5.21/160) x1
	Long					
	16.67/32	16.67/64	16.67/128	16.67/256	16.67/512	16.67/1024
No. of OFDM symbols per subframe (short/long CP)	7/6					



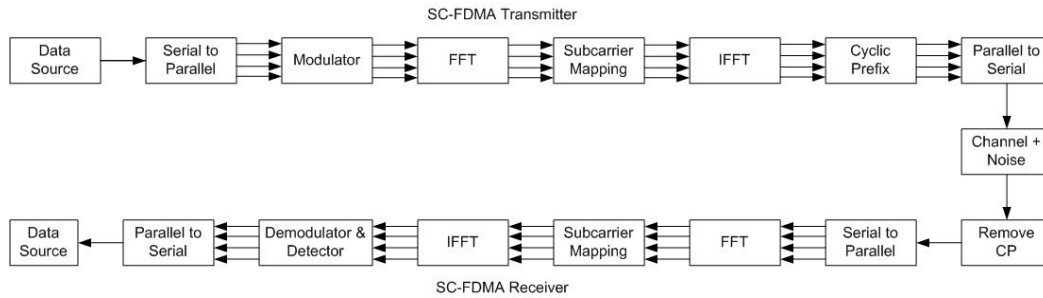

Fig 15: Block diagram of SC-FDMA system.

IV. RESULTS AND DISCUSSION

This section presents the results of simulating the model of OFDMA (Figure 13) and SC-FDMA (Figure 15) in Matlab. To realize these systems, the Additive White Gaussian Noise (AWGN) channel is taken, which is commonly used to simulate the background noise of the channel. The frequency selective (multipath) fading is introduced in the channel and the Rayleigh fading model is also used. The parameters used are mentioned in Table 5.

Table 5: Parameters used for simulation.

PARAMETERS	VALUES
Number of Sub-carriers	512 (FFT Length)
CP Length	64
Range of SNR in dB	0 to 30
Modulation	BPSK, QPSK, 16-QAM, 64-QAM
Data Block Size	16 (Number of Symbols)
Channel	AWGN (SNR = 100 dB)
System Bandwidth	5 MHz
Confidence Interval used	32 times
Fading	Rayleigh (frequency selective)
Rayleigh fading parameters	Input sample period = 1.00e-3 sec Maximum Doppler shift = 100 Hz Vector path delays = [0 2.00e-5] sec Average path gain vector = [0 -9] dB

The results obtained for different parameters are discussed below:

**1. Bit Error Rate (BER) Vs Signal to Noise Ratio (SNR):** For any modulation scheme, the BER is measured by comparing the transmitted signal with received signal, and computing the error counts over total number of bits transmitted. Mathematically, the BER is ratio of error bits and total number of bits transmitted during time interval.

$$BER = \text{Error Bits} / \text{Number of Transmitted Bits} \quad (1)$$

The SNR is the ratio of bit energy ( $E_b$ ) to the noise power spectral density ( $N_0$ ) and it is expressed in dB. The BER vs SNR of OFDMA and SC-FDMA are shown in Figures 16 & 17. Considering a specific value of BER (say  $10^{-3}$  in this case); the BPSK and QPSK has same SNR values for both OFDMA and SC-FDMA; however, a sudden change occurs in 16-QAM and 64-QAM. The 64-QAM has highest value of SNR which shows its better performance in terms of BER.

**2. Peak to Average Power Ratio (PAPR):** The PAPR is calculated by representing a CCDF (Complementary Cumulative Distribution Function) of PAPR. The CCDF of PAPR is the probability that the PAPR is higher than a certain PAPR value  $PAPR_0$  ( $\Pr\{PAPR > PAPR_0\}$ ) [14]. The PAPR of

OFDMA and SC-FDMA for BPSK and QPSK modulations are shown in Figure 18 and Figure 19 respectively. From Figures 18 and 19, it can be observed that the PAPR value of SC-FDMA & OFDMA is almost similar for both B-PSK and Q-PSK modulation schemes. The PAPR of OFDMA and SC-FDMA for 16-QAM and 64-QAM are shown in Figures 20 and 21 respectively; which shows that for SC-FDMA, the PAPR increases for higher order modulation. However, it is nearly the same for OFDMA.

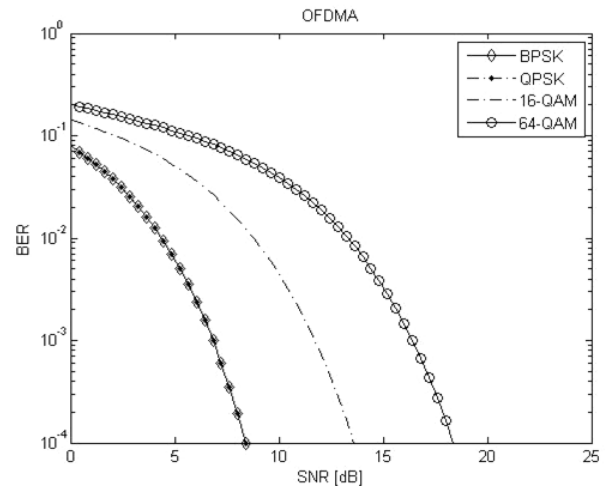

Fig 16: BER vs SNR of OFDMA with adaptive modulation.

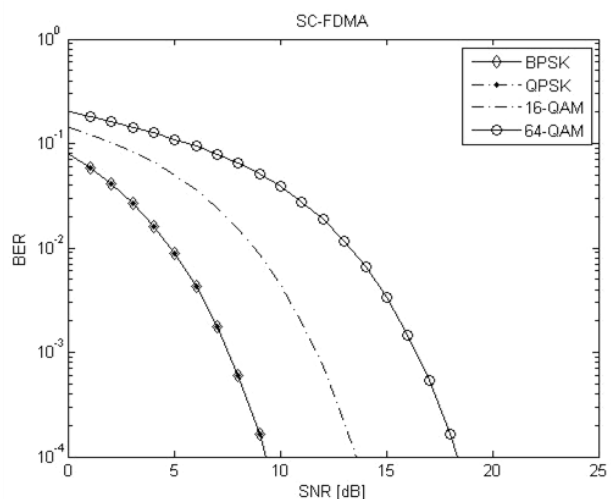

Fig 17: BER vs SNR of SC-FDMA with adaptive modulation.

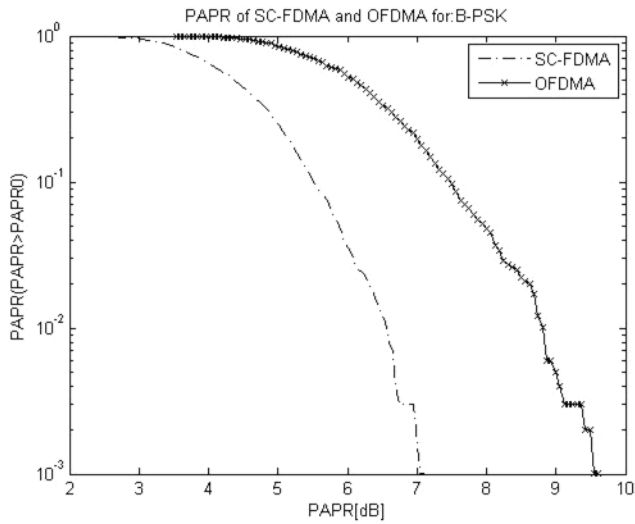

Fig 18: PAPR of OFDMA and SC-FDMA for BPSK.

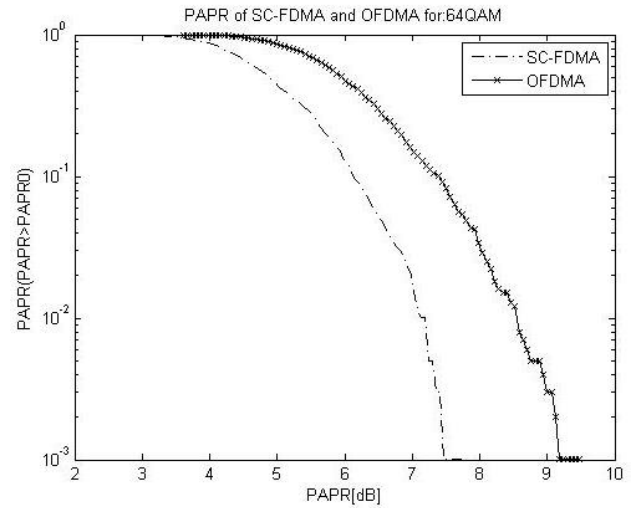

Fig 21: PAPR of OFDMA and SC-FDMA for 64-QAM.

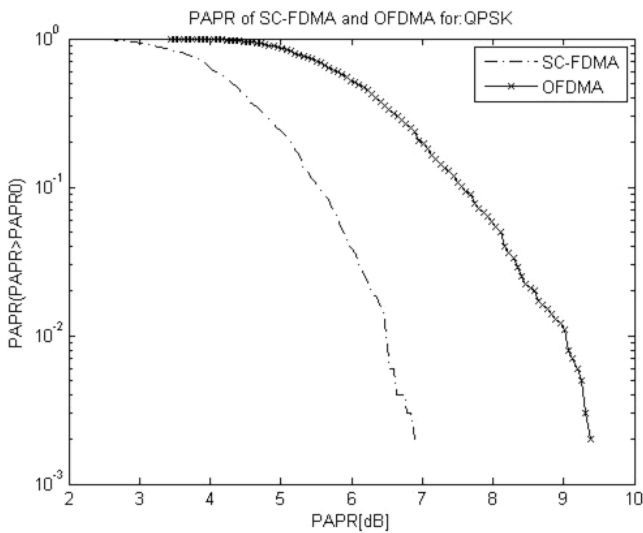

Fig 19: PAPR of OFDMA and SC-FDMA for QPSK.

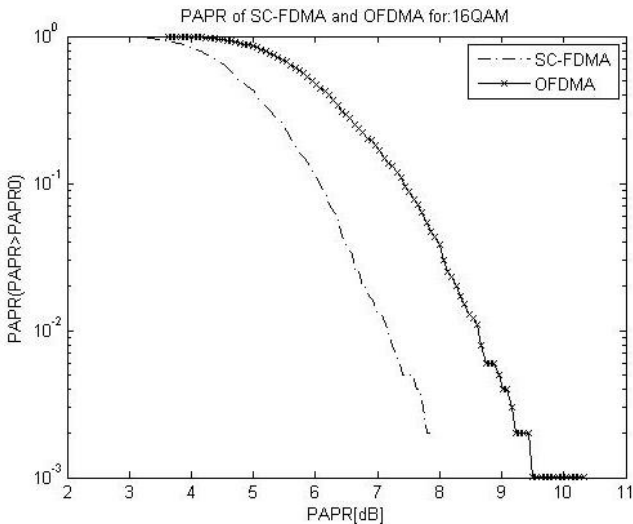

Fig 20: PAPR of OFDMA and SC-FDMA for 16-QAM.

**3. Error Probability:** The probability of error or error probability ( $P_e$ ) is the rate of errors occurs in the received signal. For coherent detection, the symbol error probability of M-ary PSK in the AWGN channel is determined by:

$$P_e \cong \text{erfc} \left[ \sqrt{\frac{2E}{N_0}} \sin\left(\frac{\pi}{M}\right) \right] \quad (2)$$

Where, E is the transmitted signal energy per symbol,  $N_0$ = Noise density in AWGN and *erfc* is the complementary error function. For M-ary QAM, the  $P_e$  is given by:

$$P_e \cong 2 \left( 1 - \frac{1}{\sqrt{M}} \right) \text{erfc} \left[ \sqrt{\frac{3E_{av}}{2(M-1)N_0}} \right] \quad (3)$$

Where,  $E_{av}$ =average value of transmitted symbol energy in M-ary QAM. The error probability graphs of OFDMA and SC-FDMA are shown in Figures 22 and 23 respectively, and the corresponding values in Table 6

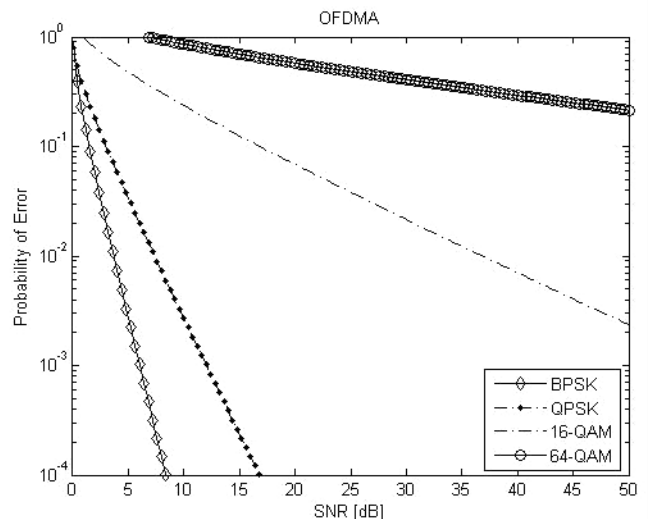

Fig 22: Error probability of OFDMA.

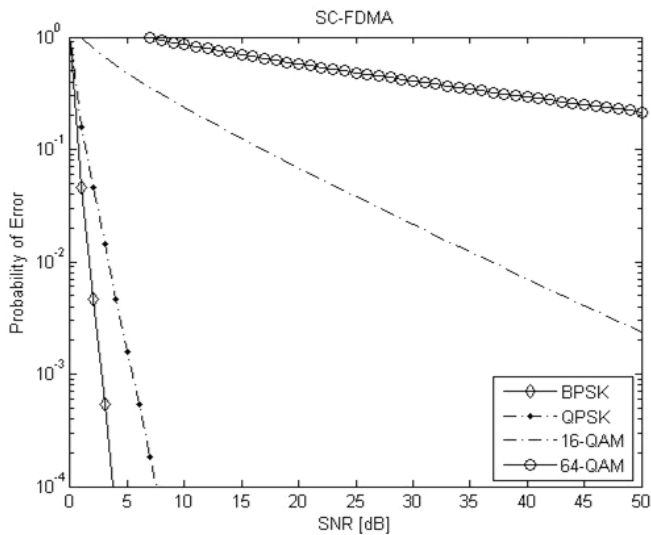

Fig 23: Error probability of SC-FDMA.

Table 6: Error probability of OFDMA & SC-FDMA.

$P_e = 1e-0.5$			
Modulation Scheme	Bits per Symbol	SNR (dB)	
		OFDMA	SC-FDMA
BPSK	1	1	1
QPSK	2	2.6	2
16-QAM	4	8.4	7.8
64-QAM	6	53	37

From Table 6, it can be seen that for a specific value of  $P_e$ , the BPSK modulation has less value of SNR as compared to other modulations. The 64-QAM has higher SNR values in both OFDMA and SC-FDMA.

### V. CONCLUSION

This paper provides the introduction to LTE and the key components of its physical layer. These descriptions are simplified version of the detailed descriptions provided by 3gpp. From the discussion, it is observed that OFDMA is used as downlink and SCFDMA as uplink modulation schemes; with OFDM as the basic building block. This paper, therefore, presents the description of OFDMA and SCFDMA; along with their Matlab based simulation results. From the simulated results, it is observed that for a fix value of SNR, the BER increases for high order modulation (16-QAM and 64-QAM) in both the multiple access techniques (OFDMA and SC-FDMA) used in LTE system. On the other hand, the lower order modulation schemes (BPSK and QPSK) experience less BER at receiver; thus lower order modulations improve the system performance in terms of BER and SNR. If the bandwidth efficiency of these modulation schemes is considered, the higher order modulation accommodates more data within a given bandwidth and is more bandwidth efficient as compared to lower order modulation. Thus, there exists a tradeoff between BER and bandwidth efficiency among these modulation schemes used in LTE. It is also concluded from the results that, the error probability increases as order of modulation scheme increases. Therefore, the selection of

modulation schemes in adaptive modulation is quite crucial based on these results.

From the simulation results, it can also be concluded that the higher order modulation schemes have an impact on the PAPR of both OFDMA and SC-FDMA. The PAPR increases in SC-FDMA and slightly decreases in OFDMA for higher order modulation schemes. The overall value of PAPR in SC-FDMA is less than that of OFDMA in all modulation schemes, and that is why it has been adopted for uplink transmission in LTE system. Based on the results obtained, it can be concluded to adopt low order modulation scheme i.e. BPSK, QPSK and 16-QAM for uplink in order to have less PAPR at user end. In nutshell, SC-FDMA is more power efficient.

### VI. REFERENCES

- [1] 3GPP, “3rd Generation Partnership Project, Technical specification group radio access network”, Physical channels and modulation (Release 8), 3GPP TS 36.211.
- [2] N. Arshad, M. A. Jamal, Dur E. Tabish & S. Saleem, “Effect of Wireless Channel Parameters on Performance of Turbo Codes”, Advances in Electrical Engineering Systems (AEES), Vol. 1, No. 3, pp. 129-134, 2012.
- [3] 3GPP, “ITU Library and archive services”, URL <http://www.itu.int/en/history/overview/Pages/history.aspx>.
- [4] J. Lee, J. K. Han and J. Zhang, “MIMO Technologies in 3GPP LTE and LTE-Advanced”, EURASIP Journal on Wireless Communications and Networking, 2009.
- [5] Y. Yang, H. Hu, J. Xu & G. Mao, “Relay Technologies for WiMAX and LTE-Advanced Mobile Systems”, IEEE Communication Magazine, October, 2009.
- [6] International Telecommunications Union, “IMT-Advanced Submission and Evaluation Process”, URL <http://www.itu.int/ITU/index.asp?category=study-groups&rlink=rsg5-int-advanced&lang=en>.
- [7] D. Astely, E. Dahlman, A. Furuskar, Y. Jading, M. Lindstrom & S. Parkvall, “LTE: the evolution of mobile broadband”, IEEE Communication Magazine, April, 2009.
- [8] 3GPP, “3rd Generation Partnership Project, Technical specification group radio access network”, Physical channels and modulation (Release 8), 3GPP TS 36.201.
- [9] T. Hong, “OFDM and its wireless applications: A survey”, IEEE transactions on Vehicular Technology, Vol. 58, Issue 4, pp. 1673-1694, May 2009.
- [10] 3GPP, “3rd Generation Partnership Project, Technical specification group radio access network”, Multiplexing and Channel Coding (Release 8), 3GPP TS 36.212.
- [11] 3GPP, “3rd Generation Partnership Project, Technical specification group radio access network”, Multiplexing and Channel Coding (Release 8), 3GPP TS 36.321.
- [12] A. Larimo, M. Lindstrom, M. Meyer, G. Pelletier, J. Torsner and H. Wiemann, “The LTE link-layer design”, IEEE communication magazine, April, 2009.
- [13] S. Stefania, I. Toufik and M. Baker, “LTE-The UMTS Long Term Evolution from Theory to Practice”, John Wiley & Sons, 2009.
- [14] 3GPP, “3rd Generation Partnership Project, Technical specification group radio access network”, Requirements for Evolved UTRA (E-UTRA) and Evolved UTRAN (E-UTRAN) (Release 7), 3GPP TR 25.913.
- [15] 3GPP, “3rd Generation Partnership Project, Technical specification group radio access network”, Feasibility study for further advancements for E-UTRA (LTE-Advanced) (Release 9), 3GPP TR 36.912.
- [16] 3GPP, “3rd Generation Partnership Project, Technical specification group radio access network”, Evolved universal terrestrial radio access (E-UTRA); Base Station (BS) Radio Transmission and Reception, 3GPP TS 36.104.

- [17] 3GPP, “3rd Generation Partnership Project, Technical specification group radio access network”, Evolved universal terrestrial radio access (E-UTRA); Base Station (BS) Conformance Testing, 3GPP TS 36.141.
- [18] 3GPP, “3rd Generation Partnership Project, Technical specification group radio access network”, Evolved universal terrestrial radio access (E-UTRA); Base Station (BS) Radio Transmission and Reception, 3GPP TR 36.804.
- [19] 3GPP, “Evolved universal terrestrial radio access (E-UTRA): User Equipment (UE) Radio Transmission and Reception”, 3GPP TR 36.807.
- [20] 3GPP, “Evolved universal terrestrial radio access (E-UTRA): Carrier Aggregation Base Station (BS) Radio Transmission and Reception”, 3GPP TR 36.808.
- [21] 3GPP, “3rd Generation Partnership Project, Technical specification group radio access network”, Physical Layer Procedures (Release 8), 3GPP TS 36.213.
- [22] H. Holma and A. Toskala, “LTE for UMTS: OFDMA and SC-FDMA based radio access,” John Wiley & Sons Inc, 2009.
- [23] J. Zyren and W. McCoy, “Overview of the 3GPP long term evolution physical layer,” Freescale Semiconductor, Inc., White Paper, 2007.
- [24] H.G. Myung and D.J. Goodman, “Single carrier FDMA: a new air interface for long term evolution,” Wireless Communications and Mobile Computing, 2008.
- [25] D. Amzallag, R. Yehuda, D. Raz and G. Scalosub, “Cell selection in 4G cellular networks”, IEEE Transactions on mobile computing, vol. 12, no. 7, pp.1443-1455, July 2013.



**Murtadha Ali Nsaif Shukur** is doing his M.Tech. (Electronics and Communication Engineering) at MM University, Mullana, Ambala, Haryana, INDIA. He has received his B. Tech (Communication Engineering) from Technical College of Al- Najaf and Diploma in (Electrical) from Technical Institute of Al-Najaf, Iraq.

**Maninder** graduated from National Institute of Technology (NIT), Kurukshetra, India in 2000 with a BTech degree in Electronics & Communication Engineering. He started his professional carrier in 2000 as Design & RF Engineer with Bharat Electronics, India. Following this role in industry, Maninder did MSc in Digital Communication from Loughborough University in 2004. He carried out his research work in the area of signal processing and was awarded a PhD in 2008 by Loughborough University for an investigation of Leak detection in Polyethylene Pipes using Signal Processing. He worked as Research Associate in the Department of Civil and Building Engineering, Loughborough University for three years and academic in MM University, Mullana, Ambala, INDIA. Presently, he is research associate in University of Ulster, UK. His main research focuses on detecting and locating leaks in water distribution plastic pipes using advanced signal processing techniques, Acoustics in pipes and Linearisers for the RF wideband amplifiers.