

COMSOL Modeling of Taguchi Optimized PEM Fuel Cell Arrays for Maximum Driving Capabilities

Jyoti Lalotra¹, Parveen Kumar Lehana²

^{1,2}DSP Lab, Department of Electronics, University of Jammu, Jammu, J&K, India

¹jyotilalotra05@gmail.com, ²pklehana@gmail.com

Abstract - PEM fuel cell provides alternative green energy with several advantages like high power density, low operating temperature, low emission, quiet operation, fast start-up, and fast shutdown. PEM fuel cell uses a solid polymer electrolyte membrane, an electrolyte, and two platinum electrodes. Nowadays, these are commonly available for automobile applications. A single fuel cell produces about one volt and a few milliamperes of current. To increase the power, multiple cells are stacked together in arrays of series and parallel configurations. In this paper, for further increase of power, a parallel array of six fuel cells connected in series in hexagonal shape are used as the building block for enhancement of current driving capabilities. Power optimization was carried out using COMSOL Multiphysics and Taguchi method. For optimization, it has been assumed that an equal amount of gases flows through the cells results in an equal amount of generated current in identical configurations.

Keywords — PEM fuel cell, Electrolyte, COMSOL, Power, Gases flow.

I. INTRODUCTION

The greed of power and energy has blindfolded the human race by triggering the never-ending process of depletion of energy resources on earth. It has alarmed to search for alternative sources of energy as a consequence of deteriorating climatic changes and rapid depletion of fossil fuels. It is time to shift to green energy; otherwise, with the pace of polluting and utilizing natural resources, the earth will not sustain further [1]. Besides this, the combustion of fossil fuels is slowly converting the composition of the eco system, and it can cause climatic disasters. Developing alternative renewable and safe resources is a goal of energy engineering to safeguard the future of the coming generations. Further, the major part of environmental pollution is contributed by using conventional techniques for generating electricity. A promising device for tackling these problems is the fuel cell. It is like a battery that generates energy from an electrochemical reaction. Both batteries and fuel cells transform chemical energy into electrical energy, but the battery supplies energy only for some specified time, and the fuel cell has the efficiency to supply energy indefinitely as long as the input supply of gases is maintained [2], [3]. Fuel cells have higher efficiency than other

conventional alternatives. Proton exchange membrane (PEM) based fuel cells use Hydrogen and Oxygen for generating electric power. Proton exchange membrane fuel cells (PEMFCs) are primarily employed in portable, stationary, and transportation applications [4]. There are many issues that PEM-based fuel cell technology is being investigated. The most important issue is the enhancement of the performance of the fuel cell by adjusting the influence of various operating and design parameters [5]. Some of the investigations recently carried out in this direction are discussed in this section.

Agnihotri et al. [6] investigated various geometry-related parameters of the fuel cells, including mass transport losses and electrodes configuration of the fuel cells. It was reported that proper geometric configuration is a must for the high performance of the fuel cells. The impact of the Gas Diffusion-Layer (GDL) parameters on the overall performance of PEMFC was investigated by Jang et al. [7]. The parameters like porosity, the thickness of the GDL, and the flow direction of the fuel were investigated with respect to cell performance. Significantly affect of the porosity, thickness of the GDL, and aligned flow pattern of gas with air was reported as important factors for enhancing the performance. Ferng et al. [8] investigated the influences of flow channel design on the efficiency of PEMFCs and also concluded that the PEMFC performance can be enhanced by a parallel flow channel with a step-wise depth design. PEMFC performance was reported as independent of depth design. Yoon et al. [9] studied the influence of gas and electric transmission of PEMFCs for optimizing flow field plates taking a various range of rib and channels widths. The narrow rib width showed improved performance of cells. GDL performed better than electric transmission. Wang et al. [10] did an experimental study of operating parameters and their effect on the performance of PEMFCs. The impact of the quantity of GDLs on a 200 cm² serpentine flow field was investigated by Shimpalee et al. [11], [12], and it was discovered that a 13-channel flow field design provides higher efficiency for PEMFC. The 26 channel flow design has better current distribution capacity at a low-pressure drop as compared to 13 channel flow. The impact of rib widths and flow channel size was also investigated. Chen et al. [13] investigated the impact of flow channels patterns on the performance of micro PEMFC and showed that bend angle improves the performance. The performance is better for



wider channels with small rib arrangements. These techniques may be applied for better design of PEMFCs. Yu et al. [14] experimentally obtained the best combination of operating parameters (temperature, pressure, humidification temperature, stoichiometric flow ratio), considering each parameter at two levels. The study shows that working pressure has the most significant impact on fuel cell performance, followed by fuel cell temperature. Kaytakoglu and Akyalcin [15] used Taguchi's method to determine the optimal operating conditions for these parameters. They found that working pressure has a higher SNR to achieve maximum stack performance. However, higher working pressures also require higher pumping power, which reduces net power efficiency. Fahim et al. [16] reviewed that the performance of PEM-based fuel cells depends upon various factors such as operating conditions, mass transport, and electrodes, but the geometric parameters of flow channels affect the overall performance of the PEMFCs. Gopalsamy et al. [17] used the Taguchi method to determine the optimum machining parameters for hard steel with an L18 orthogonal array. S/N ratio and ANOVA were employed for estimating the overall performance characteristics like cutting speed, feed, depth of cut, and width of cut while considering surface finish and tool life as the response. Results of the Taguchi method matched closely with ANOVA, and cutting speed was reported as the most influencing parameter.

In this paper, a novel geometric configuration has been proposed for supplying input gases to the fuel cell. The parameters of the configuration are optimized using the Taguchi technique [12]. The thirty-two experiments needed for specifying the response of the configuration for different levels of input parameters were conducted using COMSOL. The performance of the configuration with optimized parameters was also carried out to ascertain the Taguchi optimization. Taguchi technique and computation model of the fuel cell along with methodology are explained in Section II and Section III, respectively. The result and its discussion are presented in Section IV. Conclusion and future scope are discussed in the subsequent section.

II. TAGUCHI METHOD

In order to investigate the combined effect of several control factors on the performance of a system, the conduct of the experiments for each combination of the factors becomes a cumbersome job. Therefore, in order to make the investigations feasible, the Taguchi method can be used [18]. It provides a technique to perform the experiment with a limited number of combinations. The reduction of the levels of each factor further reduces required combinations [19]. Taguchi optimization is a systematic approach for designing efficient systems at the minimized cost of resources [20]. It uses orthogonal arrays (OA) for planning the experiments. The orthogonal array is a fractional factorial matrix, which ensures a balanced comparison of the levels and interactions among the factors. The Taguchi method can also be used for estimating the best combination of parameters to improve the

performance of the PEM fuel cell [21]. There are orthogonal arrays denoted as L4, L8, L9, L12, L16, L16b, L18, L25, L27, L32, L32b, L36, L50, L54, L64, L64b, and L81.

Taguchi method is a 2-step optimization process based on Signal-to-Noise (S/N). In step 1, control factors responsible for variability based on the S/N ratio are identified. In step 2, it identifies control factors that move the mean to the target mean value with negligible effect on the S/N [22]. The basic requirement of designing a satisfactory system is to reduce the effect of noise factors, i.e., uncontrolled factors. The standard deviation to the mean (signal) ratio is known as the S/N ratio (noise). The higher S/N ratio means more consistent quality and better system performance [23]. The signal-to-noise ratio of the optimization problem is basically divided into three types as Nominal is the best, Larger is the better, and Smaller is the better [24]. The objective function for the S/N ratio for optimization can be taken from any of the following:

$$\text{Larger is the better: } S/N = -10 \log(1/n \sum_{i=1}^n 1/y_i^2) \tag{1}$$

$$\text{Nominal is the best: } S/N = -10 \log(\frac{\overline{y^2}}{s^2}) \tag{2}$$

$$\text{Smaller is the better: } S/N = -10 \log(1/n \sum_{i=1}^n y_i^2) \tag{3}$$

Where Y denotes replies for a given factor level combination, n is the number of responses in the factor level combination, and s denotes the response of standard deviation [23], [25].

Taguchi method requires conducting the experiment at n time's, where n is no. of rows in the orthogonal array chosen for the optimization. The result of these n experiments is analyzed for estimating the optimal values of the entire dependent factor, and a final experiment is computed corresponding to the optimal parameters estimated.

III. METHODOLOGY

In the previous section, the general philosophy of the Taguchi method was presented. In the present research, it has been employed for optimizing the power density of the array of fuel cells. Each element in the array is assumed to be consist of six fuel cells connected across the edges of the hexagonal structure, as shown in Fig. 1. It has been assumed that the power output of the fuel cell is a function of gas concentration along the electrodes.

The hexagonal structure was selected on the basis of COMSOL Multiphysics-based simulation. In the structure, six fuel cells are connected in series with common inlets and outlets (Fig. 1) for each cell. One inlet/outlet pair is used for the supply of hydrogen gas and the other for Oxygen. The investigations were conducted by considering the flow of one gas at a time. Being the symmetrical configuration, the results of both the pairs are expected as the same. For the

simulation, laminar flow physics was used for estimating the velocity contours and particle tracing.

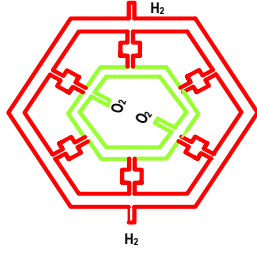

Fig.1 Fuel cell series array with a hexagonal structure for enhancing voltage

Six hexagonal units of fuel cells were connected in parallel to increase the power density (Fig. 2). The parallel array also has common inlet/outlet pairs for the supply of

gases to the fuel cells connected in the hexagonal structures. Because of the different distances of each hexagonal from the inlet/outlet pair, the flow of gases may vary, giving different power densities within each hexagonal array of fuel cells. To regulate the flow uniformly across each hexagonal unit, 12 flaps were used. It is assumed that the uniform flow can be maintained by adjusting the positions and dimensions of the flaps.

The different independent parameters affecting the power density are assumed as widths, heights, two-dimensional displacements for the 12 flaps (six for Hydrogen flow control & six for Oxygen flow control), and common input pressure. The simulation was conducted for one gas flow at a time. The description of the nomenclature of the parameters is presented in Table I.

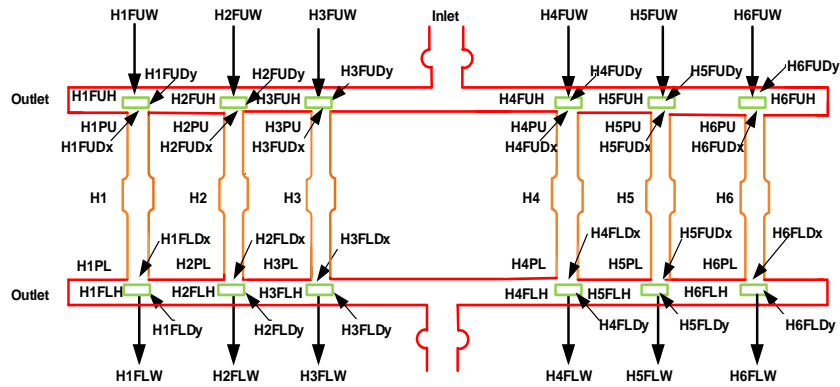

Fig.2 Parallel array of hexagonal structured fuel cell units for power enhancement

**TABLE I
PARAMETERS AND ITS DISCUSSION**

Hexagonal ID	Channel Upper Flap
H1: First Hexagonal Fuel Cell H2: Second Hexagonal Fuel Cell H3: Third Hexagonal Fuel Cell H4: Fourth Hexagonal Fuel Cell H5: Fifth Hexagonal Fuel Cell H6: Sixth Hexagonal Fuel Cell	HiFUW: Hexagonal Fuel Cell Upper Width <i>i</i> = 1,2,3,4,5,6 HiFUH: Hexagonal Fuel Cell Upper Height <i>i</i> =1,2,3,4,5,6 HiFUDx: Hexagonal Fuel Cell Upper Displacement with respect to x <i>i</i> =1,2,3,4,5,6 HiFUDy: Hexagonal Fuel Cell Upper Displacement with respect to y <i>i</i> =1,2,3,4,5,6
Channel Lower Flap	
HiFLW: Hexagonal Fuel Cell Lower Width <i>i</i> =1,2,3,4,5,6 HiFLH: Hexagonal Fuel Cell Lower Height <i>i</i> =1,2,3,4,5,6 HiFLDx: Hexagonal Fuel Cell Lower Displacement with respect to x <i>i</i> =1,2,3,4,5,6 HiFLDy: Hexagonal Fuel Cell Lower Displacement with respect to y <i>i</i> =1,2,3,4,5,6	
Input Channel	
CIP: Common Input	

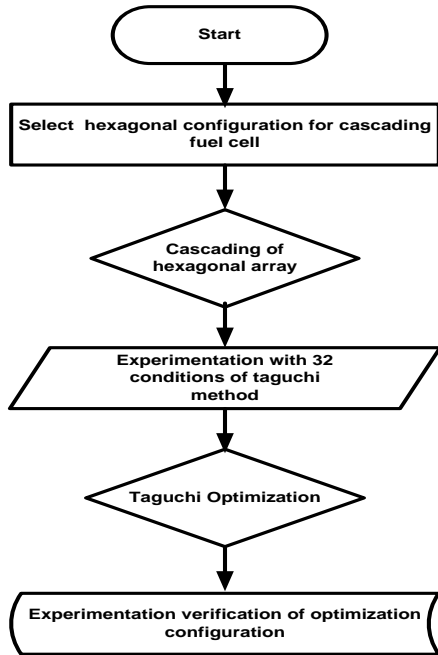

Fig. 3 Flow chart for basic steps of methodology

The overall methodology of the investigations is shown in the flowchart given in Fig. 3. First of all, a hexagonal configuration for cascading six fuel cells is simulated for the study of gas flow across each cell in the structure then the hexagonal units connected in parallel are simulated L32 orthogonal array was selected for the investigations as the number of independent parameters is 25. After conducting the thirty two experiments, the optimization of the parameters for uniform power density was carried out. Each parameter was assumed as having only two levels. The optimized parameters estimated from MINTAB were further used for the conduct of final experiment.

IV. RESULTS AND DISCUSSION

The methodology for power optimization of fuel cell arrays has been discussed in the previous section. Fig.4, shows the simulation results of the hexagonal fuel cell array for mesh structure, velocity profile, contour, and particle tracing corresponding to hydrogen gas applied from upper valve. The velocity profile (Fig. 4b) shows the gas pressure at inlet of all the six fuel cells. Small variations are also visible within the fuel cell placed near the inlet valve. Similar variations are also indicated by the pressure and particle distributions. For conducting the thirty two simulation experiments for the parallel array of hexagonal units the levels corresponding to different parameters used for investigations are shown in Table II.

S/N ratio corresponding to thirty two experiments on the basis of smaller is the better are shown in Table III, Table IV, and Table V. The formula $S/N = -10 \cdot \log(\sum(Y^2)/n)$ has been used for estimating the signal to noise ratio.

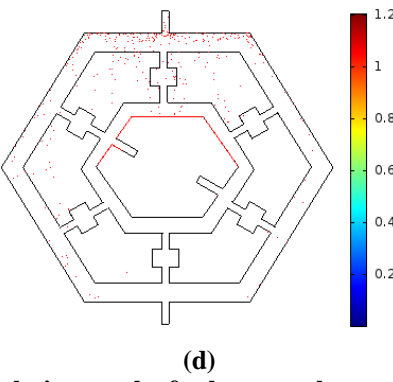
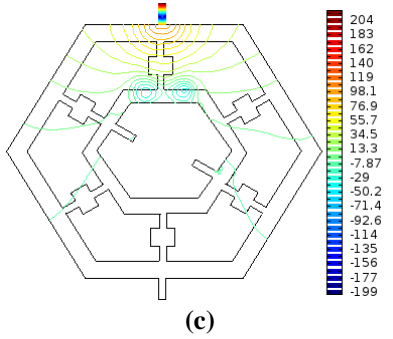
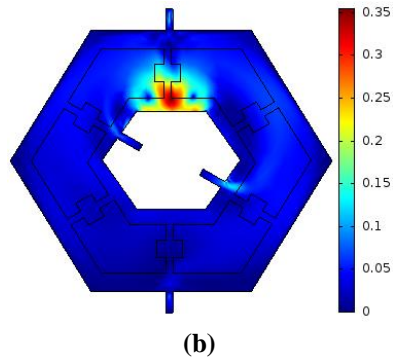
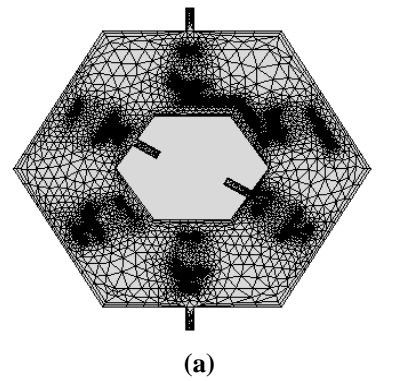

Fig. 4 Simulation results for hexagonal structure of fuel cells for enhancing the voltage. The mesh used for the simulation is shown in (a), velocity field in (b), pressure contour (c), and particle trajectories in (d)

TABLE II
SELECTION OF PARAMETERS, LEVELS AND ITS SYMBOL

Parameters	Level 1	Level 2	Symbol
H _i FUW: Hexagonal Fuel Cell Upper Width <i>i</i> = 1,2,3,4,5,6	0.3375	0.4725	 Level1 Level2
H _i FUH: Hexagonal Fuel Cell Upper Height <i>i</i> = 1,2,3,4,5,6	0.0625	0.1250	 Level 1 Level2
H _i FUDx: Hexagonal Fuel Cell Upper Displacement with respect to x <i>i</i> = 1,2,3,4,5,6	-0.3300	0.3875	 Level 1 Level2
H _i FUDy: Hexagonal Fuel Cell Upper Displacement with respect to y <i>i</i> = 1,2,3,4,5,6	6.5100	6.9350	 Level 1 Level2
H _i FLW: Hexagonal Fuel Cell Lower Width <i>i</i> = 1,2,3,4,5,6	0.3375	0.4725	 Level1 Level2
H _i FLH: Hexagonal Fuel Cell Lower Height <i>i</i> = 1,2,3,4,5,6	0.0625	0.1250	 Level1 Level2
H _i FLDx: Hexagonal Fuel Cell Lower Displacement with respect to x <i>i</i> = 1,2,3,4,5,6	-0.3300	0.2825	 Level1 Level2
H _i FLDy: Hexagonal Fuel Cell Lower Displacement with respect to y <i>i</i> = 1,2,3,4,5,6	3.8730	3.5020	 Level 1 Level 2

TABLE III
S/N RATIO SMALLER IS THE BETTER

LEVEL	H1FUW	H1FUH	H1FUDx	H1FUDy	CIP	H2FUW	H2FUH	H2FUDx	H2FUDy
1	30.98	29.95	31.24	31.45	31.28	31.25	32.58	30.43	31.28
2	29.99	31.02	29.73	29.52	29.69	29.72	28.39	30.54	29.69
Delta	0.98	1.07	1.50	1.92	1.60	1.53	4.20	0.11	1.59
Rank	13	12	10	6	7	9	2	20	8

TABLE IV
S/N RATIO SMALLER IS THE BETTER

LEVEL	H3FUW	H3FUH	H3FUDx	H3FUDy	H4FUW	H4FUH	H4FUDx	H4FUDy	H5FUW
1	30.17	28.43	31.19	32.10	28.08	32.42	30.50	30.18	30.57
2	30.80	32.54	29.78	28.87	32.89	28.55	30.47	30.79	30.40
Delta	0.64	4.11	1.42	3.23	4.82	3.86	0.03	0.61	0.16
Rank	14	3	11	5	1	4	24	16	19

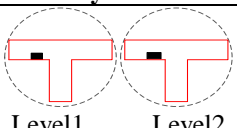
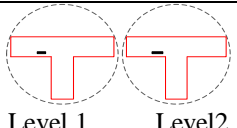
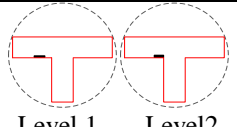
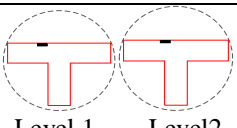
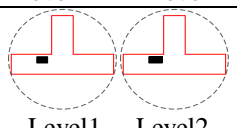
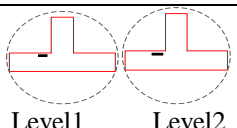
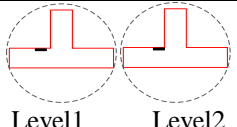
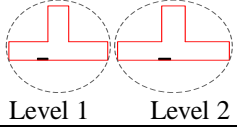
TABLE V
S/N RATIO SMALLER IS THE BETTER

LEVEL	H5FUH	H5FUDx	H5FUDy	H6FUW	H6FUH	H6FUDx	H6FUDy
1	30.72	30.80	30.51	30.28	30.44	30.49	30.53
2	30.25	30.17	30.46	30.69	30.52	30.48	30.44
Delta	0.48	0.63	0.05	0.40	0.08	0.00	0.08
Rank	17	15	23	18	22	25	21

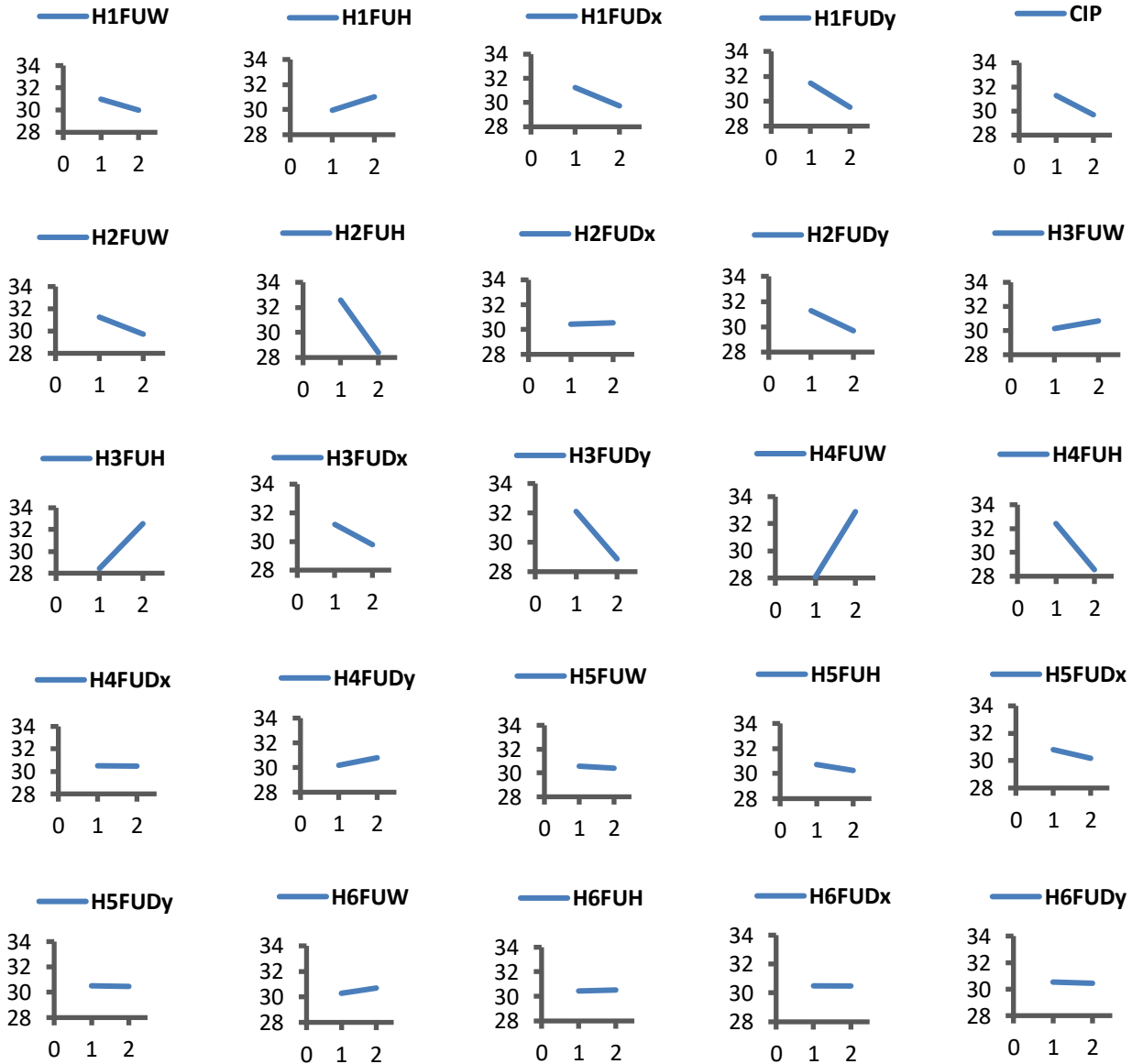

Fig. 5 Signal to noise ratio plot for “Smaller is the better”

The Graphical representations of the S/N ratio for each parameter are shown in Fig. 5. From the S/N ratio diagram the optimum level for each parameter is computed on the basis of smaller is the better and estimated value is shown in Table VI.

The thirty third experiment was conducted corresponding to optimal parameters estimated using the Taguchi method.

The results are shown in Fig. 6a, Fig. 6b, Fig. 6c, and Fig. 6d. The analysis of the mesh (Fig. 6a) and the velocity profile (Fig. 6b), pressure contour (Fig. 6c), and the particle trajectories (Fig. 6d), shows that Taguchi method is able to estimate the value of the parameters required for optimizing the power.

TABLE VI
FACTORS AND ITS LEVELS

LEVEL	H1FUW	H1FUH	H1FUDx	H1FUDy	CIP	H2FUW	H2FUH	H2FUDx	H2FUDy
1		29.95						30.43	
2	29.99		29.73	29.52	29.69	29.72	28.39		29.69

LEVEL	H3FUW	H3FUH	H3FUDx	H3FUDy	H4FUW	H4FUH	H4FUDx	H4FUDy	H5FUW
1	30.17	28.43			28.08			30.18	
2			29.78	28.87		28.55	30.47		30.40

LEVEL	H5FUH	H5FUDx	H5FUDy	H6FUW	H6FUH	H6FUDx	H6FUDy
1				30.28	30.44		
2	30.25	30.17	30.46			30.48	30.44

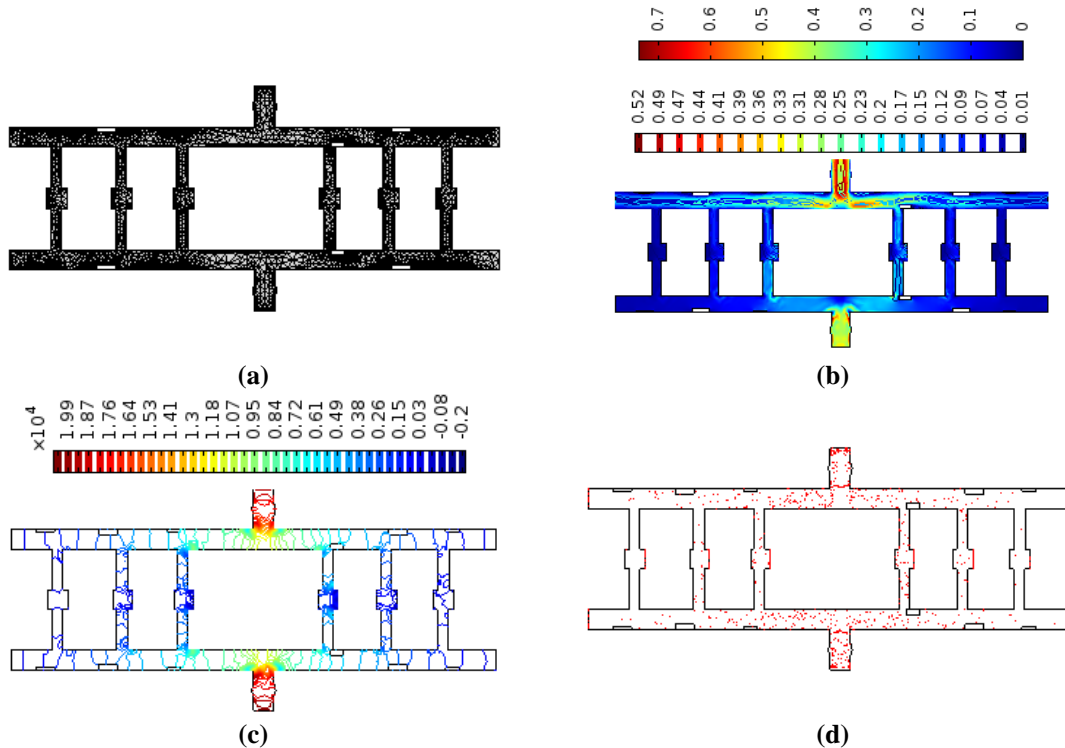

Fig. 6 Simulation results for parallel array of hexagonal structure based fuel cells for enhancing the output power corresponding to optimized parameters obtained by Taguchi method. The mesh used for the simulation is shown in (a), velocity field in (b), pressure contour in (c), and particle trajectories (d)

Simulation results of the thirty third experiment for particle tracing are shown in Fig. 6. The small variations with in the results for different fuel cells used in the optimized structure can further be reduced by increasing the number of levels of the parameters. For increasing the overall power density fuel cell arrays were connected in parallel. It is clear that adjusting the parameters can make the equal amount of gases to flows through the fuel cells leading to optimized power.

V. CONCLUSIONS AND FUTURE SCOPE

In this paper, six fuel cells were stacked in series along hexagonal edges of the gas flow system for increasing the

voltage and five units of such sub systems were connected in parallel for power enhancement. COMSOL based simulation was carried out to optimize the power of the resultant system. For maintaining the uniformity of the gas flow in each fuel cell, different configurations of flaps were used. The parameter adjustment was carried out using Taguchi optimization technique. The simulation experiments showed that almost uniform flow of gases can be maintained using the proposed technique and hence accordingly fuel cell power density can be optimized. Fabrication of the system is on our future agenda.

REFERENCES

- [1] I. Dincer, Technical, Environmental and Exergetic Aspects of Hydrogen Energy Systems, *International Journal of Hydrogen Energy*, 27(3) (2002) 265-285.
- [2] E. Andrea, M. Ma`nana, A. Ortiz, C. Renedo, L. Egu`iluz, et al., A Simplified Electrical Model of Small PEM Fuel Cell, *University of Cantabria, Spain*, 1(4) (2006) 281-284.
- [3] O. Yarguddi, Anjali and A. Dharme, *Fuel Cell Technology: A Review*, *International Journal of Engineering Research and Technology*, 3 (2014) 14668-14673.
- [4] S.S.L. Rao, A. Shaija, and S. Jayaraj, Optimization of Operating Parameters to Maximize the Current Density Without Flooding at the Cathode Membrane Interface of a PEM Fuel Cell Using Taguchi Method and Genetic Algorithm, *International Journal of Energy and Environment*, 5(3) (2014) 335-352.
- [5] V. Pavanan, and L. Varadharajan, Optimization of various Parameters for the Performance Enhancement of PEM Fuel Cell, *Indian Journal of Science and Technology*, 11(1) (2018) 1-7.
- [6] P. Agnihotri, and V.N. Lad, Membrane-less Fuel Cells: Microfluidic Fuel Cells, *Afro - Asian International Conference on Science, Engineering & Technology, AAICSET*, (2015) 27-28.
- [7] J. H. Jang, W.M. Yan, and C.C. Shih, Effects of the Gas Diffusion-Layer Parameters on Cell Performance of PEM Fuel Cells, *Journal of Power Sources*, 161(1) (2006) 323-332.
- [8] M.Y. Ferng and Ay. Su, A Three-Dimensional Fuel-Cell CFD Model Used to Investigate the Effects of Different Flow Channel Designs on PEMFC Performance, *International Journal of Hydrogen Energy*, 32(17) (2007) 4466-4476.
- [9] Y.G. Yoon, W.L. Lee, G.G. Park, T. H. Yang, and C. S. Kim, Effects of Channel and Rib Widths of Flow Field Plates on the Performance of a PEMFC, *International Journal of Hydrogen Energy*, 30(12) (2005) 1363-1366.
- [10] L. Wang, A. Husar, T. Zhou, and H. Liu, A Parametric Study of PEM Fuel Cell Performances, *International Journal of Hydrogen Energy*, 28(11) (2003) 1263-1272.
- [11] S. Shimpalee, S. Greenway, and J. W. Van Zee, The Impact of Channel Path Length on PEMFC Flow Field Design, *Journal of Power Sources*, 160(1) (2006) 398-406.
- [12] P. Karthikeyan, M. Muthukumar, S.V. Shanmugam, P.P. Kumar, S. Muralib, et al., Optimization of Operating and Design Parameters on Proton Exchange Membrane Fuel Cell by using Taguchi method, *International Conference on Design and Manufacturing, IConDM, Procedia Engineering*, 64 (2013) 409-418.
- [13] T. Y. Chen, C.H. Chen, and C.H. Chen, The Experimental Study of the Effect of Flow Pattern Geometry on Performance of Micro Proton Exchange Membrane Fuel Cell, *International Journal of Mechanical and Mechatronics Engineering*, 3(7) (2009) 803-807.
- [14] W.L. Yu, S.J. Wu, and S.W. Shiah, Parametric analysis of the proton exchange membrane fuel cell performance using design of experiments, *International Journal of Hydrogen Energy*, 33(9) (2008) 2311-2322.
- [15] S. Kaytakoglu and L. Akyalcin, Optimization of Parametric Performance of a PEMFC, *International Journal of Hydrogen Energy*, 32(17) (2007) 4418-4423.
- [16] K.H. Fahim, E.M. Alfayydh, and H.A. Dhahad, Effect of Geometric Design of the Flow Fields Plat on the Performance of A PEM Fuel Cell: A Review, *International Journal of Scientific & Engineering Research*, 8(7) (2017) 25-34.
- [17] B.M. Gopalsamy, B. Mondal, and S. Ghosh, Taguchi method and ANOVA: an approach for porous parameter optimization of hard machining while machining hardened steel, *Journal of Scientific and Industrial Research*, 68 (2009) 686-695.
- [18] A.M. Titu, A.V. Sandu, A.B. Pop, S. Titu, and T.C. Ciungu, The Taguchi Method Application to Improve the Quality of a Sustainable Process, *IOP Conference Series: Materials Science and Engineering*, 374 (2018) 1-7.
- [19] J. Chandrashekar, B. Vidyasagar, M.V. Reddy, and T. Praveen, Experimental Investigation of Turning of EN-9 using Taguchi Approach, *International Journal of Engineering Trends and Technology*, 46(7) (2017) 379-386.
- [20] S. Athreya, and Y. D. Venkatesh, Application Of Taguchi Method For Optimization of Process Parameters In Improving The Surface Roughness Of Lathe Facing Operation, *International Refereed Journal of Engineering and Science*, 1(3) (2012) 13-19.
- [21] A.C. Mitra, M. Jawarkar, T. Soni, and G.R. Kiranchand, Implementation of Taguchi Method for Robust Suspension Design, *12th International Conference on Vibration Problems, ICOVP 2015, Procedia Engineering*, 144 (2016) 77-84.
- [22] V.K. Modi, and D.A. Desai, Review of Taguchi Method, Design of Experiment (DOE) & Analysis of Variance (ANOVA) for Quality Improvements Through Optimization in Foundry, *Journal of Emerging Technologies and Innovative Research*, 5(1) (2018) 184-194.
- [23] I.O. Fagbolagun, and S.A. Oke, The Optimization of Packaging System Process Parameters Using Taguchi Method, *International Journal of Industrial Engineering and Engineering Management*, 2(1) (2020) 1-13.
- [24] E. Ginting, and M.M. Tambunan, Selection of Optimal Factor Level from Process Parameters in Palm Oil Industry, *IOP Conference Series: Materials Science and Engineering*, 288 (2018) 1-6.
- [25] D.M. Arya V. Chaturvedi, and J. Vimal, Application of Signal to Noise Ratio Methodology for Optimization of MIG Welding Process Parameters, *International Journal of Engineering Research and Applications*, 3(4) (2013) 1904-1910.