

An Integrated Cooling Tunnel for Preventing the Breakage of Chocolate Snack Bars

Mohd Syahrin Amri¹, Mohd Farriz Basar^{*1}, Muhamad Faizal Yaakub¹, A.M. Kamarul², Mustafa BinSam³

¹Faculty of Electrical and Electronic Engineering Technology, Universiti Teknikal Malaysia Melaka, Hang Tuah Jaya, 76100 Durian Tunggal, Melaka, Malaysia

²Faculty of Mechanical and Manufacturing Engineering Technology, Universiti Teknikal Malaysia Melaka, Hang Tuah Jaya, 76100 Durian Tunggal, Melaka, Malaysia

³Cerealmond Confectionery Sdn Bhd, 39, Jln 4/7 Phase 2B, Bandar Baru Selayang, 68100 Batu Caves, Selangor, Malaysia

*¹mfarriz@utem.edu.my

Abstract — Cerealmond Confectionery Sdn Bhd is a manufacturer of chocolate bars in Malaysia. The manufacturer experienced significant yield loss and decreased productivity because of chocolate bars breaking on their manufacturing line. The current industry practice entails a high level of human interaction, which contributes to the occurrence of broken chocolate bars. The project's objective is to eliminate the problem of broken chocolate bars and to increase manufacturer productivity. The analysis determined that the primary issue occurred at the rotating plate, where a thermal imaging camera recorded a temperature of 28.7°C in the rotating plate area, preventing the ingredients from cooling sufficiently to harden. The solution is to maintain a low temperature in the rotating table area, which will quickly harden the chocolate bars and resolve the broken chocolate bar issue. A food-grade cooling tunnel with an acrylic container was designed for the rotating table area, resulting in a temperature of 14.7°C. As a result of the problem being resolved, the process flow was improved, resulting in a threefold increase in UPH.

Keywords — Acrylic container; chocolate bars; cooling tunnel; thermal imaging camera; unit per hour (UPH)

I. INTRODUCTION

Cerealmond Confectionery Sdn Bhd's primary product is chocolate bars, and the company has suffered from low productivity over the years due to chocolate bar breakage. The breaking chocolate bars suffered a 30% yield loss, prompting the manufacturer to seek assistance in resolving the issue and increasing the company's productivity. The manufacturer asserted that the breakage of chocolate bars occurred as a result of manual operation and the manufacturing area's process flow. The delay in loading the chocolate bars into the freezer was claimed to be the primary cause of the breakage issue. As Maria et al. [1] mentioned, industries that are involved in the hardening process will face fragility issues, and the cooling stage is a critical stage. According to Alessandra et al. [2], the hygroscopic nature of fibres makes their application in chocolate processing quite difficult, a problem that Cerealmond Confectionery Sdn Bhd also encountered. The

definition of breakage of the chocolate bars could be referred to in Fig. 1 and Fig. 2 for reference.

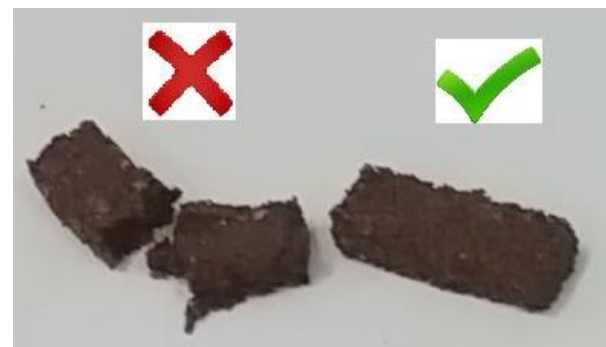

Fig.1 Chocolate snack bar acceptance criteria



Fig. 2 Breaking snack on a conveyor and pick up tray

II. MANUFACTURING PROCESS

The manufacturing process begins with the addition of the chocolate to the rotating plate along with the mixture ingredients. The rotating plate is circular in shape and has sixteen slots for forming the chocolate bars shown in Fig. 3. The purpose of this project is to eliminate the chocolate bar issue and to improve the low UPH manufacturing process that Cerealmond Confectionery Sdn. Bhd. Currently faces. The chocolate bar process flow had been analyzed in order to determine the root cause of the breaking chocolate bar issue.



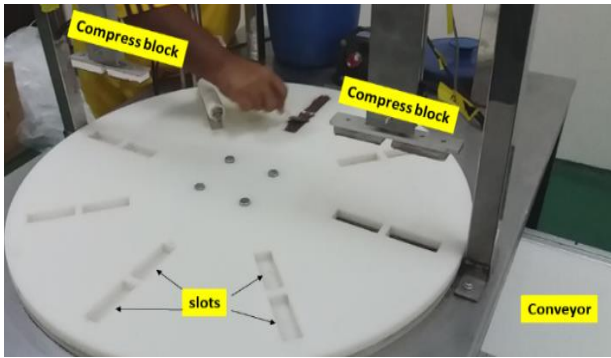

Fig. 3 Rotating plate

The chocolate is then compressed in the rotating table slots by the equipment block, and the compressed chocolate bars fall onto the conveyor and then into the collecting tray. The operator will inspect the tray and then manually place it in the freezer for ten minutes to harden. Manual operations involving operators had been mapped as flow diagrams in accordance with Fig. 4.

According to Junchao Lu et al. [3], the traditional method of inspecting finished products is no longer sufficient to meet consumer demand. With current manual practices, the UPH has been impacted, while production costs have increased as a result of the additional inspection process required. Because the company is experiencing a bottleneck, improvement activities are required to increase the UPH and productivity [4,5,6]. Each processing activity, as depicted in Fig. 4, was mapped and analyzed to discover

the primary cause of the problem and the best solution for the company. The critical area for further investigation has been identified as the rotating table, conveyor, and freezer loading process.

III. EVALUATION PLAN

It is critical for Cerealmund Confectionery to maintain a low temperature in the production area in order to ensure that the chocolate bars are solid and difficult to break. However, due to the large manufacturing area, the temperature cannot be maintained at an optimal level for the chocolate to remain hardened. Thermal imaging cameras will be used to analyze [7] the critical process area in order to determine the root cause. Thermal imaging cameras are an effective method for analyzing the temperature performance of physical objects [8], as they capture the infrared reflection from physical objects [9]. From the overall investigation, the team determined that the critical area that caused the issue of the broken bar is the rotating plate. Using a thermal imaging camera as one of the screening methods [10], it was determined that the current rotating plate area had a temperature of 28.7°C, as depicted in Fig. 5. Nuria Devos [11] asserted that chocolate at 27°C has an unstable structure and that temperature has a significant influence on its formation, and this finding is consistent with the broken chocolate bars encountered during the manufacturing process.

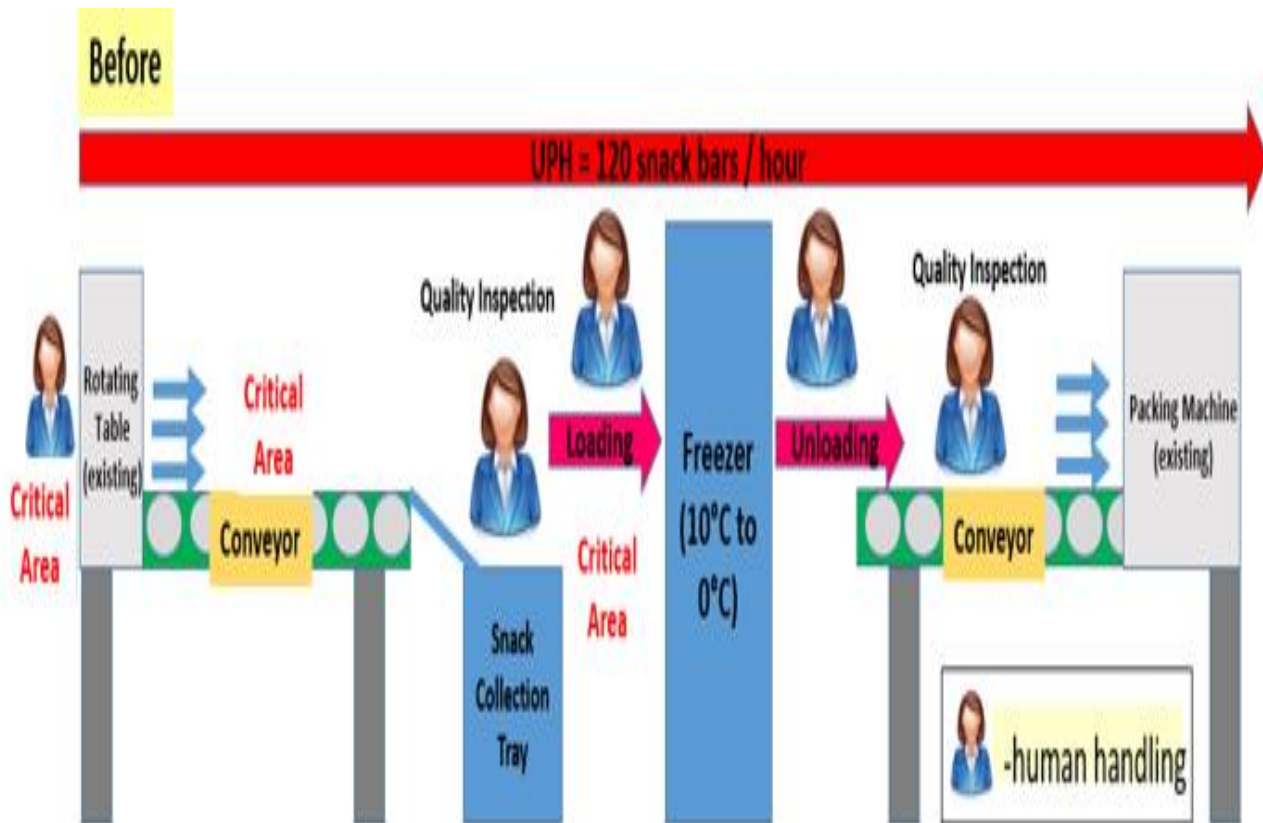

Fig. 4 Existing manufacturing process flow

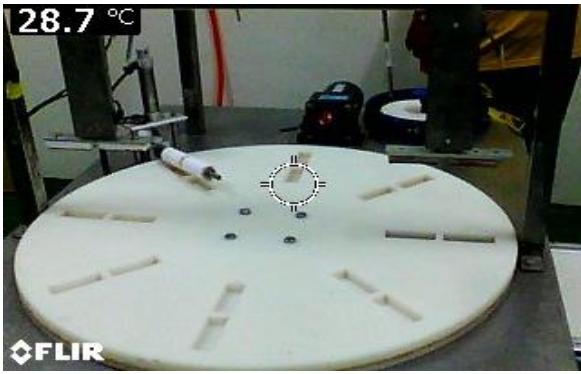

Fig. 5 Rotating plate temperature

Even though the manufacturing area was air-conditioned, the low temperature in the rotating plate area could not be maintained due to the open area. With a rotating plate temperature of 28.7°C, the chocolate ingredients have a low bond to one another, which may result in micro-cracks when compressed by the compressed block. When a microcrack occurs, the chocolate bars will break even if they are placed in the freezer due to the separation that occurs prior to the freezing process. The freezer temperature was maintained between 0°C and 10°C. The team chose to keep the temperature lower in the rotating plate area to allow the chocolate bars to harden in their slots. The idea is to harden it at an early stage, thereby eliminating the need for a freezer and shortening and speeding up the process flow. With a more efficient process flow, the company's productivity (UPH) will increase as well. The evaluation plan may be referred to as Fig. 6.

A. Rotating Plate

Rotating plate is the first process in the chocolate manufacturing process at Cerealmund Confectionery Sdn. Bhd. This area requires the operator to manually insert the chocolate ingredient into the slots before compressing it and pushing it into the conveyor. The rotational table speed is critical for producing high-quality chocolate bars. Rotating plate structures that resemble blades are common in industrial applications and are of significant technical significance [12]. There are two settings for evaluating the rotational speed of an existing rotating plate, which include a minimum of 5 mm/s and a maximum of 10 mm/s. Due to the unsuitable temperature monitoring in this area, the team decided to install a cooling tunnel to lower the temperature and ensure that the chocolate bars hardened quickly, resolving the issue.

B. Cooling Tunnel

The cooling tunnel was designed to maintain a cool temperature in the rotation plate area. The nozzles can accelerate airflow for maximum propulsion efficiency, and that by maintaining a low temperature on the rotation plate, chocolate bars can quickly harden and eliminate breakage [13]. Heat prevention or reduction, thermal moderation,

and heat dissipation are the three primary types of passive cooling systems[14]. The Cooling Tunnel was constructed using 316 Stainless Steel, which is suitable for food use and is used in a wide variety of industrial applications [15]. Smith et al. [16] also mentioned that cooling tunnels have the effect of reducing exposure to conditions of heat stress, which will help minimize the broken chocolate bar issue in this situation. The drawing design can be compared to Fig. 7 below. The cooling tunnel's final features include a temperature controller, a filter, an emergency button, and an exhaust hose, as illustrated in Fig. 8. The cooling tunnel is equipped with the refrigerant R410A and has a cooling capacity of 9,000 Btu/h, a power rating of 1,015 Watts, and a blower capacity of 175 CFM. R410A is also extensively performed in residential heating and cooling systems[17] and is classified as a high-pressure fluid [18]. The cooling tunnel temperature will be analyzed in the Design of Experiment (DOE) in relation to a minimum [19] and maximum value. Once it reaches the collecting tray, the output response target is to have no broken bars. The cooling tunnel's minimum temperature setting will be 17°C, and its maximum setting will be 20°C.

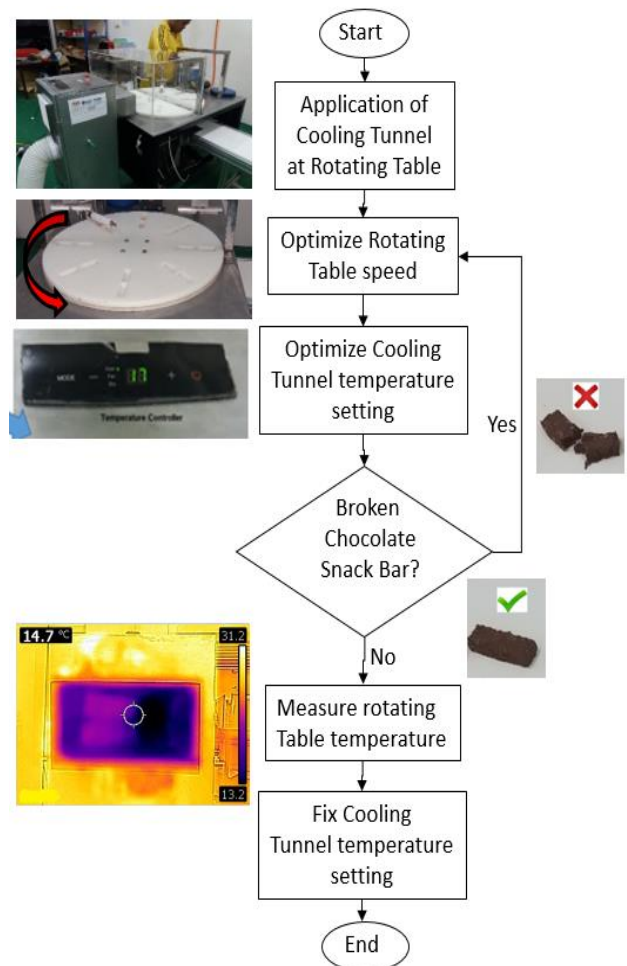

Fig. 6 Evaluation plan process flow

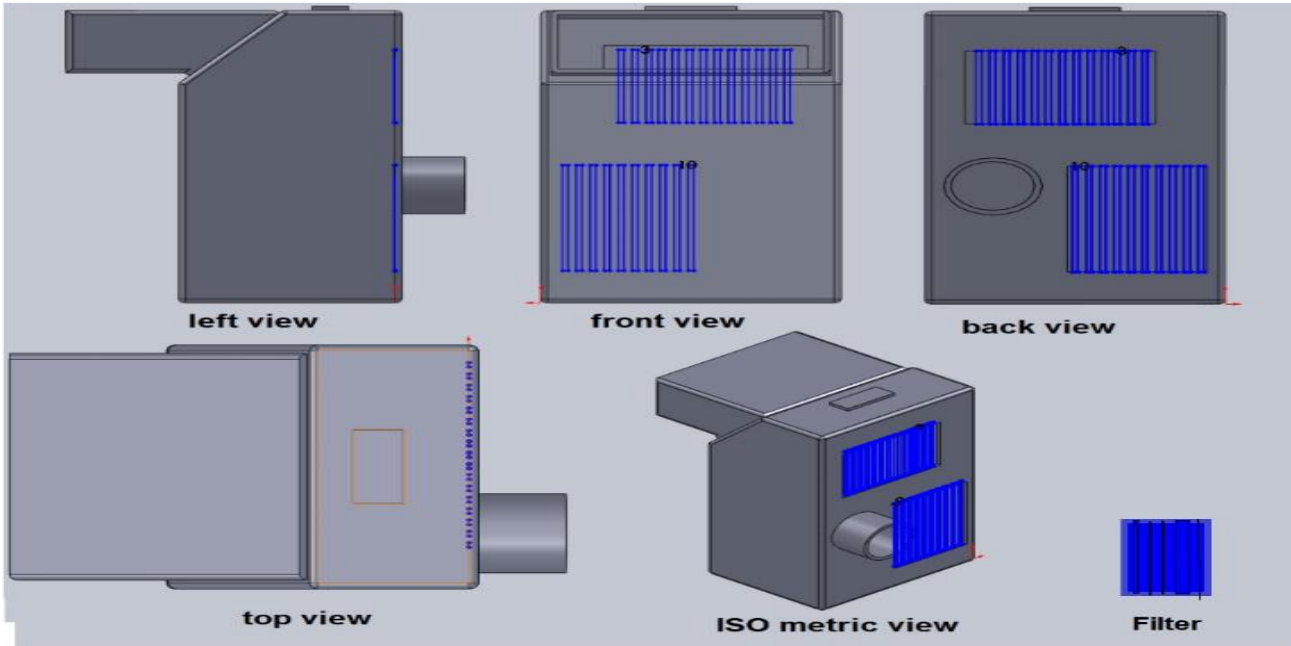

Fig. 7 Cooling tunnel design

The exhaust hose is used to direct hot air away from the chocolate manufacturing area, preventing it from affecting the temperature of the chocolate bars and risking their bonding. The filter is used to ensure that only clean air [20] is directed toward the chocolate bars. The emergency button is located on top of the cooling tunnel to ensure the safety of the process operators. According to Thomas Arnold et al. [21], the emergency red button's purpose is to interrupt a system that has created a threat, thereby minimize the hazards.



Fig. 8 Actual cooling tunnel

C. Acrylic Container

There is a requirement to evaluate an acrylic container by allocating it to the cooling tunnel blower in order to contain the rotating plate's low temperature. Acrylic is used because it is inexpensive and simple to fabricate, and it also does not require high-tech equipment [22]-[26]. The low temperature in the acrylic container ensures that the chocolate bars harden more quickly after filling the

chocolate process in the rotating plate, which eliminates the occurrence of broken chocolate bars. The acrylic design shown in Fig. 9 is used to contain the low temperature in the rotating plate area. It is critical to determine whether the acrylic container is necessary to resolve the issue by including it in the DOE as specified in Table 1. The evaluation will compare two conditions: a cooling tunnel with an acrylic container and one without.



Fig. 9 Acrylic container

Table 1 summarizes the overall Design of Experiments (DOE) to ascertain the optimal conditions for achieving zero chocolate bar breakage. For the Cooling Tunnel, 0 denotes the condition with a minimum temperature of 17°C and 1 denotes the condition with a maximum temperature of 20°C. 0 represents the cooling tunnel without the acrylic container, while 1 represents the cooling tunnel with the acrylic container. 0 indicates the minimum speed of the rotating table, which is 5 mm/s, and 1 indicates the maximum speed of 10 mm/s. All of the above-mentioned items will be evaluated to determine their effects and performance in achieving zero chocolate bar breakage.

**TABLE I
DOE RUN**

Number of runs	Cooling Tunnel Temperature	Acrylic Container	Rotating Table Speed
Run 1	0	0	0
Run 2	0	0	1
Run 3	0	1	0
Run 4	0	1	1
Run 5	1	0	0
Run 6	1	0	1
Run 7	1	1	0
Run 8	1	1	1

IV. PERFORMANCE ANALYSIS

A monitoring was conducted to determine the frequency of broken chocolate bars during all engineering runs. Fig. 10 illustrates the overall monitoring results. The monitoring is based on three rotations of the rotating table. One turn of the rotating table produces 16 chocolate bars, and the total evaluation run produces 48 chocolate bars in three turns, as previously stated. The results indicated that in order to achieve a chocolate bar issue-free environment at Cerealmond Confectionery Sdn. Bhd., the conditions in Run 3 should be met. The conditions for Run 3 are as follows: the lowest cooling tunnel temperature of 17°C, an acrylic container, and a minimum table speed of 5 mm/s. Several runs were conducted with this condition setting, and the results demonstrated conclusively that no broken chocolate bar was observed on the conveyor or in the collecting tray in full production mode, as illustrated in Fig. 11.

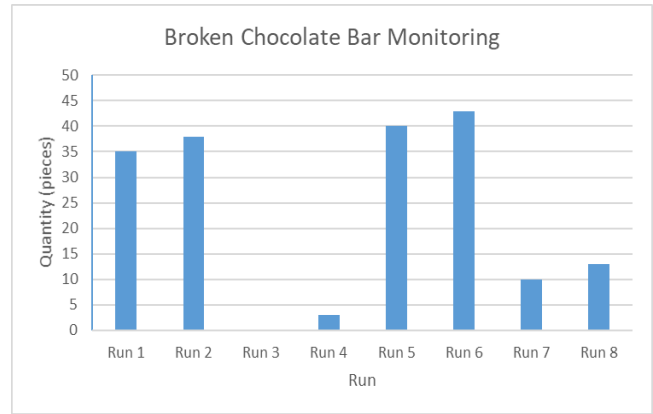

Fig. 10 Monitoring results



Fig. 11 No broken snack bar on collecting tray

Additional analysis is being conducted with the use of a thermal camera to determine the real-time temperature with the cooling tunnel and the acrylic container in the run 3 setting. The thermal camera was pointed at the cooling tunnel blower and the results indicated that the temperature was around 14.7 °C in real time, as illustrated in Fig. 12. Due to the absence of broken chocolate bars during the trial run, it can be concluded that temperatures of 14.7 °C or lower can harden the chocolate without causing breakage. Laura stated that the optimal storage temperature for crystalline kinetics was around 15°C [23], and the results corroborated this.

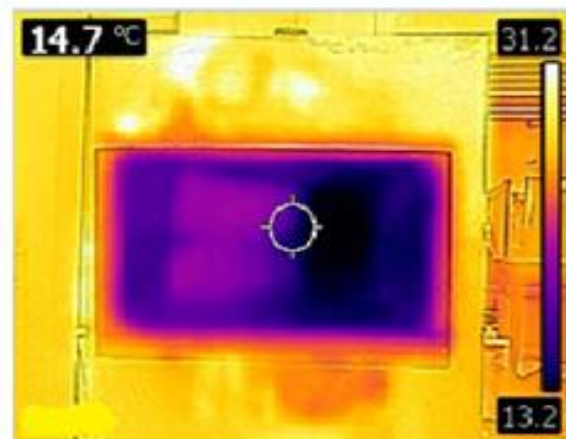

Fig. 12 Cooling tunnel temperature analysis

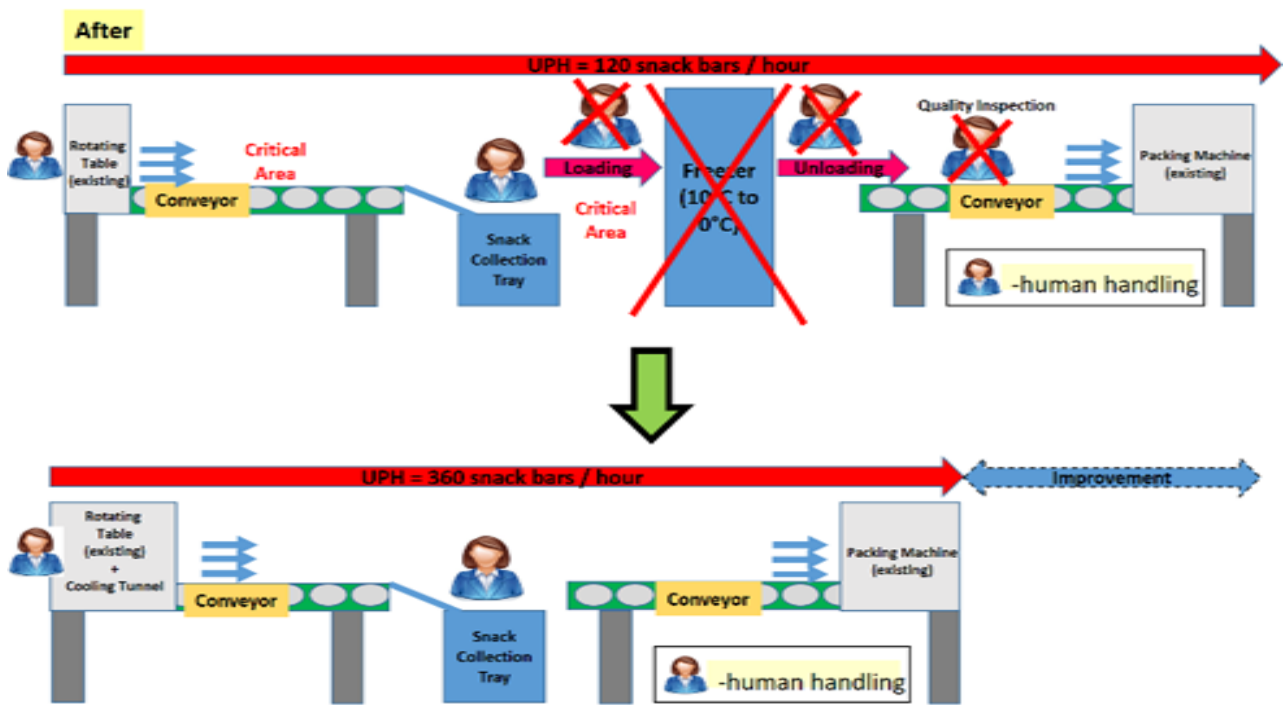

Fig. 13 Improved process flow

UPH will enable users to make more quantifiable and objective judgments about the system's performance [26]. The new process flow began with the addition of a cooling tunnel to the rotating table, followed by a conveyor length reduction to shorten the process time. Due to the fact that the chocolate bars had been hardened previously, the new process did not require the use of a freezer. The new solution avoided the freezer's loading and unloading, which had a substantial influence on UPH performance. Due to the elimination of 60% of the manual operation process, the UPH increased threefold, increasing the existing 120 chocolate bars per hour to 360 chocolate bars per hour. The elimination of the freezer and the loading and unloading process resulted in a reduction in production costs, which clearly benefits the manufacturer in terms of increased profits.

V. CONCLUSIONS

The integrated cooling tunnel resolved the issue of broken chocolate bars on the Cerealmond Confectionery SdnBhd manufacturing line completely. The project's goal of eliminating broken chocolate bars and increasing manufacturer productivity has been accomplished. The observation established that the primary source of braking chocolate was at the rotating plate, which had a temperature of 28.7°C as measured by a thermal imaging camera. For the rotating table area, a food-grade cooling tunnel with an acrylic container was designed to maintain a temperature of 14.7°C and allow the ingredients to cool sufficiently and harden.

As a result of the problem being resolved, the process flow was improved, resulting in a threefold increase in UPH. With no yield loss, the Unit Per Hour (UPH)

increased threefold over the previous performance. The manual loading and unloading process to the freezer was eliminated, resulting in a significant increase in Cerealmond Confectionery SdnBhd productivity. Since machine perception is the fastest technology available in today's world, it is advantageous to replace human tasks with machines in order to increase productivity in the majority of manufacturing companies. The cooling tunnel is then used as a new process flow on the manufacturer's line, which improves overall productivity performance.

ACKNOWLEDGMENT

The Public-Private Research Network (PPRN) grant, GLUAR/PPRN/2017/FTK-CARE/G00052, supported this research, and the authors like to express their appreciation to Universiti Teknikal Malaysia Melaka (UTeM) and the Ministry of Higher Education (MOHE) for their support and contributions to this publication. Additionally, the team would like to express gratitude to Cerealmond Confectionery Sdn. Bhd. for the opportunity to collaborate on resolving company issues and ensuring the project's success.

REFERENCES

- [1] M. A. Reinheimer, S. F. Mussati, and N. J. Scenna, Optimization of operating conditions of a cooling tunnel for production of hard candies, *J. Food Eng.*, 109(1) (2012) 22–31, doi: 10.1016/j.jfoodeng.2011.10.009.
- [2] A. B. Verde, I. D. Alvim, V. Luccas, and R. M. Vercelino Alves, Stability of milk chocolate with hygroscopic fibers during storage, *Lwt*, 137 (2020) 110477, 2021, doi: 10.1016/j.lwt.2020.110477.
- [3] J. Lu, X. H. Pua, C. Te Liu, C. L. Chang, and K. C. Cheng, The implementation of HACCP management system in a chocolate ice cream plant, *J. Food Drug Anal.*, 22(3) (2014) 391–398, doi: 10.1016/j.jfda.2013.09.049.

- [4] T. Nakamura et al., Improvement of C2W Collective Bonding Reliability and UPH through Innovations in Machine, Materials and Methods, Proc. - Electron. Components Technol. Conf., pp. 108–115, 2017, doi: 10.1109/ECTC.2017.47.
- [5] Z. Zhirong, C. Song, and M. Lixin, Stud bump process for flip-chip research: Improve UPH of stud bump, Proc. - 2013 14th Int. Conf. Electron. Packag. Technol. ICEPT (2013) 6–10, doi: 10.1109/ICEPT.2013.6756409.
- [6] T. Y. Wang and H. C. Pan, Improving the OEE and UPH data quality by Automated Data Collection for the semiconductor assembly industry, Expert Syst. Appl., 38(5) (2011) 5764–5773, doi: 10.1016/j.eswa.2010.10.056.
- [7] J. Saleh Ahmed et al., An experimental comparison between the actual valve and benchmark valve using modified design and optimized design, International Journal of Engineering Trends and Technology, 68(2) (2020) 64-73
- [8] J. Logeshwaran, RM Nachiappan, S. Nallusamy, N. Ethiraj, A Review on Development of Effectiveness Evaluation in the Manufacturing System, International Journal of Engineering Trends and Technology 68(11) (2020) 129-136.
- [9] D. G. Pestana, F. Mendonca, and F. Morgado-Dias, A low cost FPGA based thermal imaging camera for fault detection in PV panels, Internet Things Glob. Community, IoTGC 2017 - Proc., (2017), doi: 10.1109/IoTGC.2017.8008976.
- [10] Y. M. Elbarawy, R. S. El-Sayed, and N. I. Ghali, Local entropy and standard deviation for facial expressions recognition in thermal imaging, Bull. Electr. Eng. Informatics, 7(4) (2018) 580–586, doi: 10.11591/eei.v7i4.1230.
- [11] N. Devos, D. Reyman, and S. Sanchez-Cortés, Chocolate composition and its crystallization process: A multidisciplinary analysis, Food Chem., 342(2021)128301, doi: 10.1016/j.foodchem.2020.128301.
- [12] S. H. Hashemi, S. Farhadi, and S. Carra, Free vibration analysis of rotating thick plates, J. Sound Vib., 323 (2009) 1–2, 366–384, doi: 10.1016/j.jsv.2008.12.007.
- [13] Mohammad Omar Temori, František Vranay. Heat pump systems: A mini review. International Journal of Innovative Research and Scientific Studies, 4 (2) (2021) 94-104.
- [14] M. Hassan, Abbas, Hyowon Lee, and Segyu Oh. Challenges Of Passive Cooling Techniques In Buildings: A Critical Review For Identifying The Resilient Technique. Jurnal Teknologi 78(6) (2016). doi:10.11113/jt.v78.5748.
- [15] I. Tolosa, F. Garciandía, and F. Zubiri, Study of mechanical properties of AISI 316 stainless steel processed by 'selective laser melting', following different manufacturing strategies.,(2010) 639–647, doi: 10.1007/s00170-010-2631-5.
- [16] T. R. Smith et al., Evaporative tunnel cooling of dairy cows in the southeast. II: Impact on lactation performance, J. Dairy Sci., 89(10) (2006) 3915–3923, doi: 10.3168/jds.S0022-0302(06)72434-1.
- [17] C. Yıldırım, D. B. Özkan, C. Onan, C. Yıldırım, D. B. Özkan, and C. Onan, Theoretical study of R32 to replace R410A in variable refrigerant flow systems, 0750 (2017), doi: 10.1080/01430750.2016.1269682.
- [18] Cavallini, A., G. Censi, D. Del Col, L. Doretti, G.A. Longo, and L. Rossetto. Experimental investigation on condensation heat transfer and pressure drop of new HFC refrigerants (R134a, R125, R32, R410A, R236ea) in a horizontal smooth tube. International Journal of Refrigeration 24(1) (2001), 73-87. doi:10.1016/s0140-7007(00)00070-0.
- [19] S. Thepa, K. Kirtikara, J. Hirunlabh, and J. Khedari, Improving indoor conditions of a Thai-style mushroom house by means of an evaporative cooler and continuous ventilation, Renew. Energy, 17(3) (1999) 359–369, doi: 10.1016/S0960-1481(98)00761-7.
- [20] C. Liu et al., Transparent air filter for high-efficiency PM 2.5 capture, Nat. Commun., 6 (2015), doi: 10.1038/ncomms7205.
- [21] T. Arnold and M. Scheutz, The 'big red button' is too late: an alternative model for the ethical evaluation of AI systems, Ethics Inf. Technol., 20(1) (2018) 59–69, doi: 10.1007/s10676-018-9447-7.
- [22] A. Bucur and L. Stefanescu, Management of patients with squamous cell carcinoma of the lower lip and N0 - Neck, J. Cranio-Maxillofacial Surg., 32(1) (2004) 16–18, doi: 10.1016/j.jcms.2003.08.005.
- [23] L. T. Rodriguez Furlán, Y. Baracco, J. Lecot, N. Zaritzky, and M. E. Campderrós, Effect of sweetener combination and storage temperature on physicochemical properties of sucrose free white chocolate, Food Chem., 229 (2017) 610–620, doi: 10.1016/j.foodchem.2017.03.002.
- [24] T. Wang and H. Pan, Expert Systems with Applications Improving the OEE and UPH data quality by Automated Data Collection for the semiconductor assembly industry, Expert Syst. Appl., 38(5) (2011) 5764–5773, doi: 10.1016/j.eswa.2010.10.056.
- [25] S.V. Sergeev, Mahmood Shaker albdeiri, O.B. Beshevi Development of a technique for surface treatment of a rotary machine, International Journal of Engineering Trends and Technology 68(9) (2020) 31-35.
- [26] V. Mykhailov, A. Zahorulko, A. Zagorulko, B. Liashenko, and S. Dudnyk, Method for producing fruit paste using innovative equipment, Acta Innovations, 39(2021) 15–21, doi: 10.32933/actainnovations.39.2.