

Development of Classification System of Rice Milling Machine Using IoT Control

B. Muangmeesri^{#1}, A. Theddee^{*2}, T. Patanasakpinyo^{*3}, D. Maneetham^{*4}

¹ Industrial of Technology Faculty, Valaya Alongkorn University, Thailand

² Industrial of Technology Faculty, Valaya Alongkorn University, Thailand

³ Industrial of Technology Faculty, Valaya Alongkorn University, Thailand

⁴Department of Mechatronics Engineering, Rajamangala University of Technology Thanyaburi, Thailand

drple2003@hotmail.com, dechrit_m@hotmail.com

Abstract - At present, in Asia, many counties grow rice for eating and selling. But still lacking the rice milling machine used in the community. The development of this rice milling machine will focus on the development of renewable energy. Using solar energy to solar cells will be controlled by the Internet of Things (IoT) and convenience control. The result of the experiment for the theory and experiment for using an energy-saving rice milling machine. This makes it possible to save costs per household because it can use natural energy for 3 hours per day while controlling via IoT system and then can see the operation and estimates of the electrical system's use. At the same time, it can measure the value of the electric current at any time. This allows the system to be used energy efficiency and can be monitored and measured.

Keywords: Rice Machine, Solar Cell, Internet of Things, Automation.

I. INTRODUCTION

The rice milling machine uses an electric motor or engine. It is a rice milling machine with a production system and a complete rice milling process. This starts with the separation of impurities first, and then the rice husks are removed using marbles or husks. By will get brown rice then rough and fine while marbles are used to get white rice then polished with a steel grid that will get white rice. The white rice may go to the rice is not white or spoiled by using the color launcher will get white rice that is more beautiful [4], [7]. Rice milling machines at present are available in many sizes according to production capacity. Which can be divided into four sizes as follows 1) community size has a production capacity of not more than 10 tons per day 2) small size with a production capacity of 10 – 40 tons per day 3) medium size with a production capacity of 40 – 100 tons per day and 4) large capacity with a production of 100 tons or more. Simultaneously, rice milling machines have to take into account the electricity-saving so as not to affect farmers or rice mill users. Because it is an electronic invention that directly converts solar energy into electrical energy. Solar cells are made from semiconductors, absorbing solar energy and converting it into electricity [2]. Where the resulting electricity is direct current, reduce the environmental impact from other forms of electricity generation such as power generation from oil or coal and promote and

cultivate awareness of clean electricity production technology and the operation of the system must improve the efficiency of communication from a distance by using the control system via IoT [3]. To monitor cycle time and analyze the root cause of problems that arise both during and during the process and the continuous data collection for a long time [14]. It can also analyze working conditions very carefully.

This paper is organized as follows. In section II, the research method of the rice milling machine is presented. Solar panels, SCADA, and IoT control systems are presented in section III, and In section IV presents experimental results and conclusion.

II. RESEARCH METHOD

A. Solar Panel

This type of solar panel is made from silicon with high purity and has a long service life for the solar cells used, and the approximate size is 992*1955*35 mm. The power consumption of polycrystalline solar panel is 330 watts. The open-circuit voltage (Voc) for this solar panel is 46.20 volts, and the short circuit current (Isc) has 9.33 amps and to control the operation of the AC Motor with a size of 5 HP or 3.725 KW. So the size of the solar panel 330 wats must provide at least 16 solar panels to allow the rice milling machine to work without sunlight within 3 hours a day.



Fig 1: Solar Panel

B. Solar Panel Design

The designed system for 3.275 KW can operating Photovoltaic (PV) with the peak power system. We can be obtained a starting method.

$$P_m = (N_2 * V_m) * (N_1 * I_m) \quad (1)$$



$$P_m = (N_2 * 0.85 * V_0) * (N_1 * 0.85 * I_s)$$

$$P_m = 3.2KW$$

The module circuit current of the maximum power point (MPP), the energy consumption, and are connected parallel circuit, the total circuit voltage need to be supplied as 460 V and open circuit = 38.3 V, I_s is short circuit current = 8.96 A. Therefore,

$$V_0 = 12 * 38.3 = 459.6V$$

The inverter can be determined as the following equation.

$$V_{dc} = \frac{2\sqrt{2}V_{LL}}{3} \tag{2}$$

$$V_{dc} = 433V$$

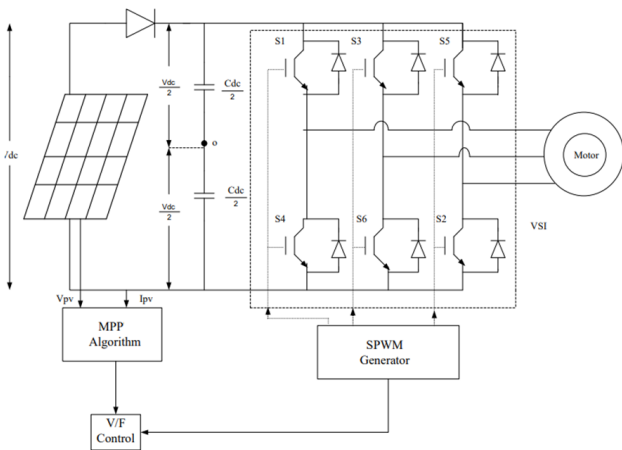

Fig 2: The designed system of PV

Calculate the value of the capacitor is:

$$C_{dc} = \frac{6 * \theta * V * I_m * t}{[V_{dc(ref)}^2 - V_{dc1}^2]} \tag{3}$$

$$C_{dc} = \frac{6 * 1.2 * 135 * 8.96 * 0.005}{[460^2 - 433^2]}$$

$$C_{dc} = 1806\mu F$$

C. Rice Mill Machine

A case study of rice milling machines has to develop and focus on building strength at the community level. Increase bargaining power in the rice market mechanism system with a suitable mill size production system, short process and efficient machinery for milling brown rice and white rice. There is softness in color, less broken. Able to preserve all the useful nutrients of rice in its entirety. This is to add the product's value to Thai rice products to maintain its leadership as a world producer of high-quality rice. It has been widely accepted that it is truly a factory and is suitable for community enterprises. This rice milling machine is designed and developed using an AC motor with 5 HP, 27 Amp current, and 1450 RPM speed. The transmission of power from the motor through the V belt. Simultaneously, all parts of the machine are connected by the transmission shaft, belt, and pulley. Able to remove

rice from five channels such as white rice, brown rice, broken rice, rice husk, and chaff.

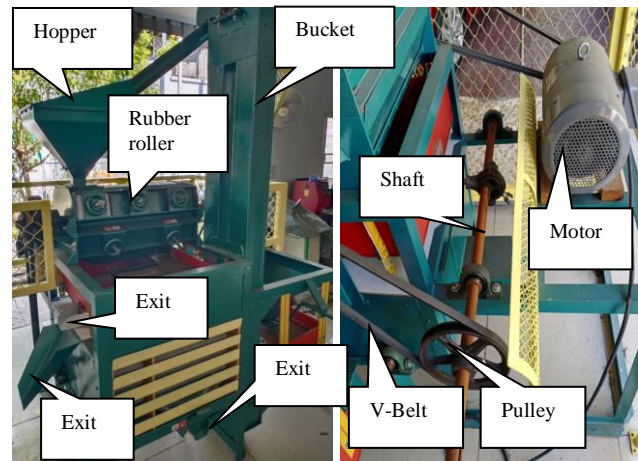

a) hopper and machine b) motor, shaft, and belt

Fig 3: Rice Milling Machine

This rice milling machine is more than 80% efficient. As shown in table 1, achieving good rice and this rice milling machine's operation can work continuously with very little impurities on the rice. The efficiency of the rice milling machine can be found as follows.

- a) The rice milling machine efficiency can be obtained as:

$$M_c = \frac{W_c}{W_m} * 100$$

Where M_c = the rice milling machine Efficiency

W_c = weight of paddy in the hopper

W_m = weight of paddy outside hopper

- b) The rice milling machine rate can be obtained as:

$$M_r = \frac{W_m}{T_m}$$

Where M_r = the rice milling machine rate

T_m = the rice milling machine time

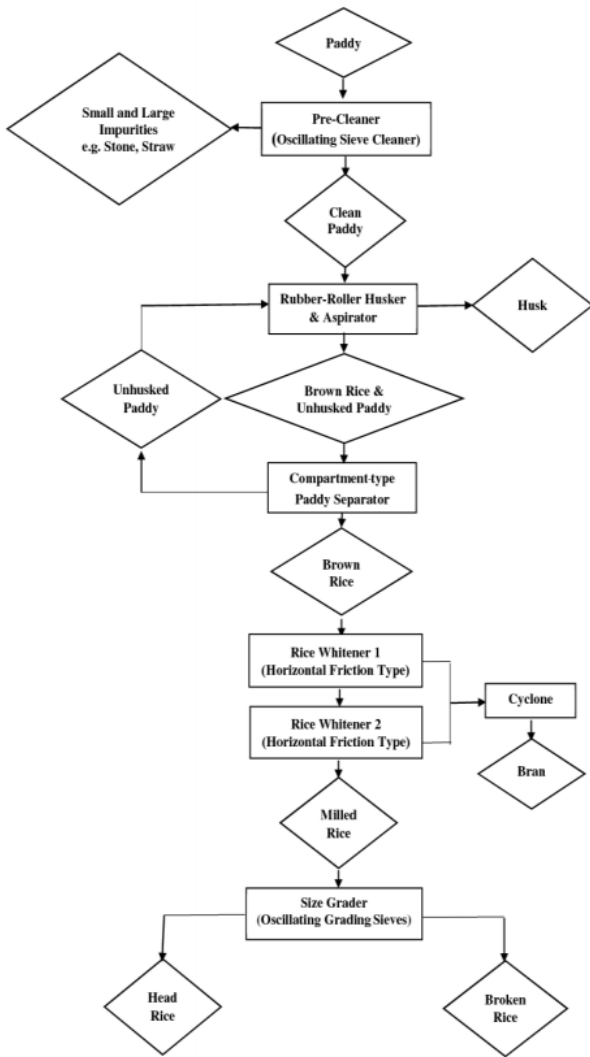

Fig 4: Flowchart of rice milling machine process

TABLE I
THE PERCENTAGE MILL AND RICE GAIN

Rice gain	Mill gain	Unmilled gain	Broken gain	Percentage mill
500	400	30	70	85
1000	650	100	250	83
1500	850	150	500	82
2000	900	300	800	80
Average	700	145	405	82.5

The rice milling machine's performance characteristics, the color of paddy can be instantly turned into milled rice, with a channel separating the chaff and bran together in one compartment. It flows through a steel sieve with a small hole filter the grits, broken rice, small pieces of rice to separate into another channel. The white level can be adjusted for various rice levels, which can be separated by the following characteristics.

1. White rice



2. Brown rice



3. Broken rice



4. Rice husk



5. Chaff



Fig 5: Type of rice

D. Battery system

When the solar panel cannot receive light such as at night, batteries are suitable for use in photovoltaic systems. Use a deep cycle battery, which is specially designed for solar cell systems. It will serve to control the charging current into the battery and increase the battery's service life. Which must be equal or greater than the current (Amp) that flows through the solar panel to the battery. In our case battery module, the charge controller's size should be larger than the solar panel's current. The capacity of the battery can be calculated as follows.

$$\text{Battery size} = \frac{c * n}{0.85 * 0.6 * V_{\text{system}}} \quad (4)$$

Where:

0.85 = power loss in battery size

0.6 = depth of discharge

V system in the voltage = 48 V

c = capacity of battery

n = working days

To calculate the daily capacity of a battery, it can be calculated as follows:

$$\text{Battery capacity to run 3 days} = \frac{3752wh}{0.85 * 0.6 * 48v} * 3days$$

$$\text{For the battery capacity} = 459.8 \text{ Ah} = 120 \text{ A}$$

So that, battery required = 1 battery*459.8 AH/120A
 = 3.8316 batteries
 = 4 batteries

E. SCADA and Internet of Things

Supervisory control and data acquisition (SCADA) is a real-time monitoring and analysis system used for remote monitoring and the control of industrial control systems and various engineering systems. SCADA consists of two parts: 1) the upper-level user interface and operations 2) the SCADA remote control unit can reduce disruptions in the industrial and engineering process as the user can recognize and remotely correct incidents [15]. In addition to greatly improving work efficiency also help reduce the cost for the organization and a significant reduction in the number of people in the surveillance. By being controlled from a remote computer instead. This solar rice milling machine will be powered by a SCADA system and controlled via the Thing (IoT) system. It will use the HMS Ewon Flexy device and WebNMS IoT platform to work together to access and analyze and generate insights. The control system consists of Beckhoff PLC CPU CX9020, Flexy 205, including software that is used as a catcher, eBuddy, eWON are used as VPN client. So eWON software also away as a router and gateway for communication.

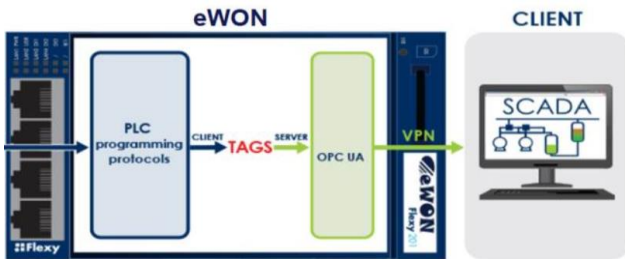

Fig 6: SCADA System

The IoT-based SCADA system will work together and manage the entire system. It improves the efficiency of the work that can monitor the system at all times and is a system that can manage, maintain, or check the voltmeter value and good electric current. In the system, analysis and visualization are the keys to building IoT applications [13]. Find basic statistical inclusions to help make decisions and make simple plans. The advanced analysis is finding relationships or the importance of insights. There is a computer program to help calculate according to various sciences such as mathematics, applied statistics, data mining, data science, etc.

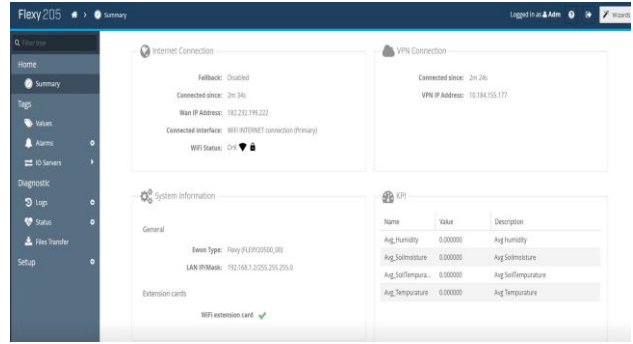

Fig 7: Flexy 205 System

Another important piece of information that should be analyzed is information about machine maintenance. We will focus on predictive maintenance, a system that monitors and analyzes data from various machine parameters. To maintain in time before the machine is broken. It is a continuous check of the parameter or various states of the machine. Users may perform more of the working behavior of machines. It has been tested to be good and accurate to indicate that the machine fails or has problems. At the same time, IoT to help display motor data and analyze operation with IoT system, ready for the rice milling machine status display. Real-time data analysis results via web browsers and can view data through other devices such as mobile phones, tablets, and so on. When machines have problems, alerts can send alert messages, get various channels, and export files in different formats.

III. EXPERIMENTAL AND RESULTS

This rice milling machine test can be controlled via a SCADA system, Modbus RTU and Modbus TCP or connected to other devices including Modbus RTU, Modbus TCP, CC-Link LON work with discrete IO to control external circuits and will receive pulse signal such as those from PLC, the counter can be used to measure and store motor power. Power consumption and the size of the load that can be used in the system.

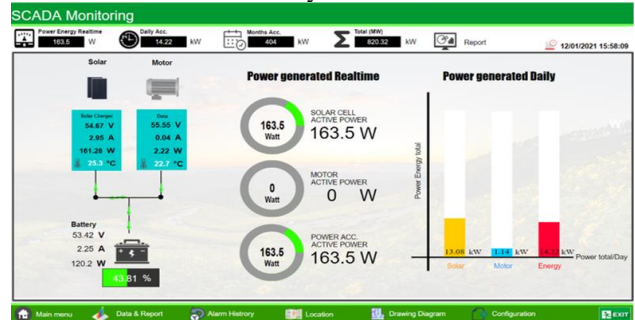

Fig 8: SCADA Monitoring

Solar panels are an innovation that is used to convert solar energy into electric energy. The resulting electric energy is direct current. Most of our home appliances tend to use AC power, and then we can convert DC electricity into AC through the inverter. The SCADA system can display results through the screen, as shown in the Figure below.

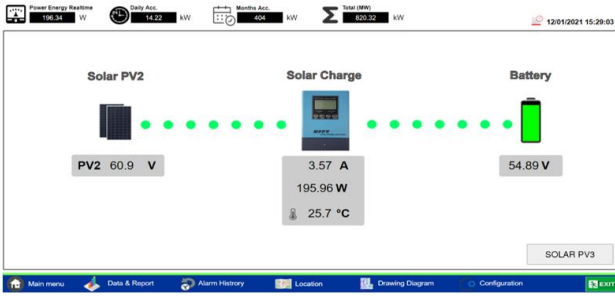

Fig 9: Solar Charge

The operation of the rice milling machine can be collected in real-time while the rice mill is used and the rice mill is not used. It can record which farmer used the rice mill at the time. How much power of the motor is used. The voltage and current are used, making it possible to promptly calculate the cost to income and expenditure and can be obtained.

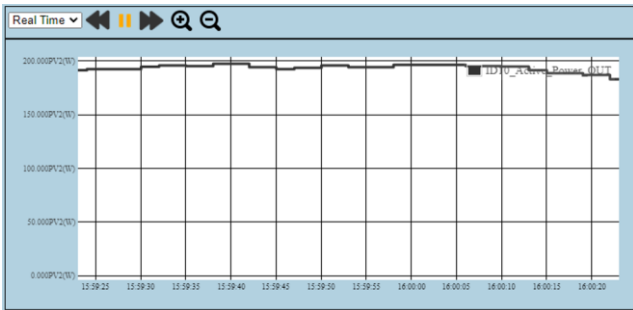

Fig 10: Shows the usage of motor

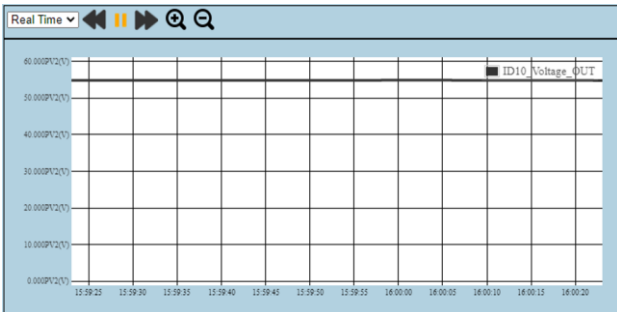

Fig 11: Shows the voltage consumption in the system

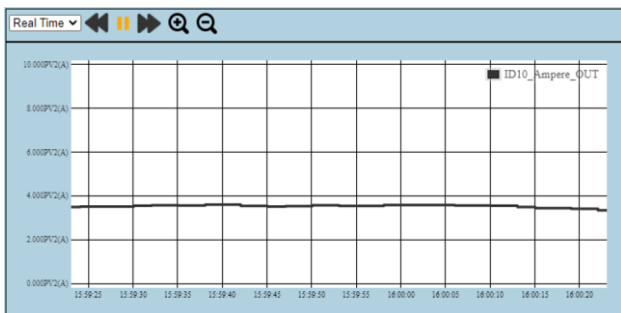

Fig12:Shows the current consumption in the system

IV. CONCLUSION

Testing this rice milling machine using solar energy controlled through a SCADA system to collect and analyze various data via a real-time monitoring system and via IoT system is a modern and fast system. The power test from solar panel to control AC motor size 3.725 KW and 27 Amp, the rice milling machine can work continuously. The values displayed by the monitor can be analyzed for various working conditions such as brightness or sunlight hardness throughout the day as well as being able to forecast the weather for how many hours the rice can be continuously milling today due to insufficient electrical system problems, it can also communicate and inform the farmers in advance. The smoothness of the electric current is very good, so it will not affect the motor system. For days without sunlight, the power system backed up on the battery can be used continuously within 1 day. For solar panels, strength, durability, and more than 10 years of solar exposure can be guaranteed.

Finally, this rice milling machine works very efficiently, and it can mill rice amount better than 82.5 %, which results in cost savings in the long run and saves farmers from the cost of milling each rice.

ACKNOWLEDGMENT

We thank the rector of Nation Innovation Agency (NIA), Thailand and The heading of the Acknowledgment section, and Valaya Alongkorn Rajabhat University for supporting the development of science and technology conditions.

REFERENCES

- [1] H. Qamar, H. Qamar, and M. U. Khan, "Solar Irradiance & On Solar Power System with Net Metering in Pakistan," *Advanced in Science, Technology Engineering Systems Journal*, 1(2016) 1-5.
- [2] S. Biswas, and A. K. Paul., A Solar Cell-based Inverter for Submersible Pumps, *International Conference on Advancement in Engineering, Applied Science and Management*, (2018)1-3.
- [3] N. M.Tech, and B. Kunjithapathan.,Design and Implementation PV Energy System for Electrification Rural Areas., *International Journal of Engineering and Advanced Technology*, 8(2019).
- [4] Y. Nagasaka, K. Tamaki, K. Nishiwaki, M. Saito, Y. Kikuchi, and K. Kobayashi.,Autonomous rice field operation project in NARO., *International Conference on Mechatronics and Automation (IEEE)*, 870-874, (2011).
- [5] R. F. Fernanda, M. S. Alfarisi, and P. P. Sagita., The Optimal Design in Using Solar Photovoltaic Power for SCADA to Improve System Availability: *International Conference on Technology and Policy in Circuit Power and Energy*, (2020).
- [6] C. Hsing, and J. J. Shieh.,Solar Energy Powered Bicycle for Wireless Supervisory Control and Remote Power Management Applications., *International Conference on Electrical Machine and System (IEEE)*, (2010) 1-4 .
- [7] T. Kodama, and Y. Hata.,Development of Classification of Rice Disease Using Artificial Intelligence., *International Conference on System, Man, and Cybernetics,(IEEE)*, 3699-3702 (2018).
- [8] M. Saputra, A. Syuhada, and R. Sary.,Study of Solar Wind Energy Using as Water Pump Drive Land for Agricultural Irrigation., *International Conference on Science and Technology (IEEE)*, (2010) 1-4.
- [9] M.R.S Muthusinghe, S.T. Palliyaguru, W.A.N.D. Weerakkody, A.M. H. Saranga, and W.H Rankothge, Towards Smart Farming: Accurate Prediction of Paddy Harvest and Rice Demand., *International Conference on Humanitarian Technology (IEEE)*, (2018) 1-6.
- [10] H. Min, S. Shuang, X. X. Bing, C. F. Bo, and Z. Y. Bin.,Why high grain yield can be achieved in single seedling machine transplanted

- hybrid rice under dense planting conditions, *Journal of Integrative Agriculture*, 17(6)(2018) 1299-1306.
- [11] H. Terzioğlu, and F. A. Kazan., The Designing of a Wducational Solar Panel That can be Controlled in Different Ways., *International Conference on Information Science and Control Engineering*, (IEEE), (2015) 960-964.
- [12] R. J. Tom, and S. Sankaranarayanan.,IoT based SCADSA Integrated with for Power Distribution Automation,” *International Conference on Information Systems and Technologies*, (IEEE)(2017) 1-4.
- [13] M. Zamanlou, and M. T. Iqbal.,Development of an Economical SCADA System for Solar Water Pumping in Iran,” *International Conference on IoT, Electronics, Mechatronics*, (IEEE), 1-4(2020).
- [14] R. Dugyala, N. H. Reddy, and S. Kumar.,Implementation of SCADA Through Cloud-Based IoT Decices- Initial Design Steps., *International Conference of Cloud Computing with the Internet of Things*, (IEEE)(2019) 1-6.
- [15] L. O. Aghenta, and M. T. IqbalN., Development of an IoT Based Open Source SCADA System for PV System Monitoring., *International Conference of Electrical and Computer Engineering*, (IEEE), 1-4(2019).
- [16] K. Medrano, D. Altuve, K. Belloso, and C. Bran., Development of SCADA using an RTU based on IoT controller.,*International Conference on Automatica*, (IEEE)(2018) 1-6.