

Original Article

Enhancing Gas Sensor Accuracy through Ripple Rejection in Switching Power Supplies

Apinan Aurasopon¹, Sanya Kaunkid², Wanchai Khamsen³, Nawarat Piladaeng¹

¹Faculty of Engineering, Mahasarakham University, Mahasakham, Thailand.

²Department of Engineering and Technology, Faculty of Science and Technology, Nakhon Pathom Rajabhat University, Nakhon Pathom, Thailand.

³Faculty of Engineering, Rajamangala University of Technology Lanna Lampang, Thailand.

²Corresponding Author : sanya@webmail.npru.ac.th

Received: 25 March 2024

Revised: 21 June 2024

Accepted: 31 July 2024

Published: 28 August 2024

Abstract - This research investigates methods to improve the accuracy of gas sensor measurements by mitigating the effects of voltage ripple in switching power supplies. Voltage ripple, inherent in switching power supplies, can introduce fluctuations in the power delivered to gas sensors, leading to inaccuracies in gas concentration measurements. In this study, we compare the performance of digital filtering techniques and a proposed ripple rejection method in reducing the impact of voltage ripple on gas sensor measurements. The experimental setup involves testing gas sensors under varying conditions of voltage ripple using both linear and switching power supplies. Digital filtering algorithms are applied to sensor data to attenuate voltage ripple effects, while the proposed ripple rejection method involves sensing and compensating for voltage ripple directly at the power supply input. Results from both methods are compared in terms of accuracy, precision, stability, and response time of gas sensor measurements. The findings of this study provide insights into the effectiveness of different approaches for mitigating voltage ripple effects in gas sensor applications. Furthermore, the research sheds light on practical strategies for improving the reliability and accuracy of gas sensor measurements in real-world environments.

Keywords - MQ gas sensors, TGS gas sensors, Switching power supply, Ripple voltage.

1. Introduction

Gas sensors, particularly those from the MQ series and TGS gas sensor families, play a critical role in various fields, including environmental monitoring, industrial safety, and healthcare, by detecting and quantifying the concentration of target gases in the atmosphere. The accuracy and reliability of gas sensor measurements are paramount for ensuring the effectiveness of gas detection systems in detecting hazardous or pollutant gases [1-4].

One crucial factor impacting the accuracy of gas sensors is the stability of the power supply. Typically, these sensors require a consistent voltage supply of 5.0 V to heat the sensing element and provide bias voltage for the sensor resistor based on the divider circuit [1-4]. Any deviation from this voltage may result in inaccurate gas measurements. While linear power supplies like the constant voltage integrated circuit LM7805 or the adjustable voltage LM317 can be utilized, issues with temperature and long-term stability often lead to voltage discrepancies, particularly when supplying high currents for sensor arrays [5]. To mitigate these concerns, switching supplies are favoured for their efficiency and compactness [6]. However, switching power supplies

generates voltage ripples, potentially compromising the accuracy of gas measurements.

Hence, to enhance the precision of MQ series and TGS gas sensor families, this study aims to achieve the following objectives:

1. Assess the impact of ripple voltage on gas measurement accuracy.
2. Implement a digital filter to mitigate the effects of ripple voltage.
3. Develop a feed-forward technique to counteract ripple voltage interference.

The structure of the paper unfolds as follows: In Section 2, we delve into the challenges posed by power sources and the constraints associated with diverse gas sensor responses. Section 3 introduces a method aimed at mitigating power voltage source disturbances. The simulations and experimental results are presented in Sections 4 and 5, offering insights into the proposed methodology. Section 6 engages in a comprehensive discussion of the work, providing a deeper understanding of the research. Finally, Section 7 encapsulates the findings, offering conclusive remarks and insights into the presented work.



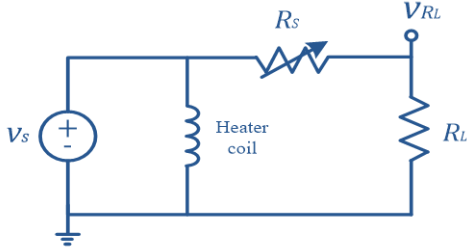

Fig. 1 Equivalent circuit of MQ sensor

2. Problem Statement

In this section, the author presents an equivalent circuit of a gas sensor [1, 2], outlines the process of determining gas volume, and examines the influence of ripple voltage on measurement accuracy.

2.1. Gas Sensors Equivalent Circuit

The equivalent circuit of an MQ sensor, depicted in Figure 1, comprises four main elements: Power Voltage Source (v_s), the heater coil, Sensor Resistance (R_s), and reference resistor or Load Resistor (R_L). The heater coil is indispensable as it maintains the sensor at an elevated temperature, which is essential for optimal sensor functionality. Typically, the heater coil is depicted as a resistor in the circuit, symbolizing the electrical power needed to heat the sensor. R_s represents the resistance of the metal oxide semiconductor material within the sensor, which varies in response to different gases, enabling gas detection. R_L , an external resistor, contributes to shaping the sensor's response characteristics and is integral to the overall circuit design.

2.2. Gas measurement with an Ideal Power Source

Typically, the process of determining gas volume begins with measuring the Output Voltage (v_{R_L}) as illustrated in Equation (1). Subsequently, Equation (2) is employed to calculate the sensor resistance, R_s , using a constant voltage of $v_s = 5.0 \text{ V}$ [1, 2].

$$v_{R_L} = \frac{(R_L \cdot v_s)}{(R_s + R_L)} \quad (1)$$

$$R_s = \left(\frac{5.0 \cdot R_L}{v_{R_L}} \right) - R_L \quad (2)$$

Several methods are available for converting R_s to gas concentration in Parts Per Million (ppm). However, microcontroller calculations are limited to two decimal places, leading to potential rounding errors when using logarithmic equations. To mitigate this issue, our study employs the power curve fitting method, as outlined in Equation (3) [7, 8].

$$\text{Gas Concentration (ppm)} = a(R_s/R_0)^b \quad (3)$$

The term R_0 denotes the sensor resistance in a clean air environment as measured experimentally, while the coefficients a and b are estimated from the sensor data sheet [7].

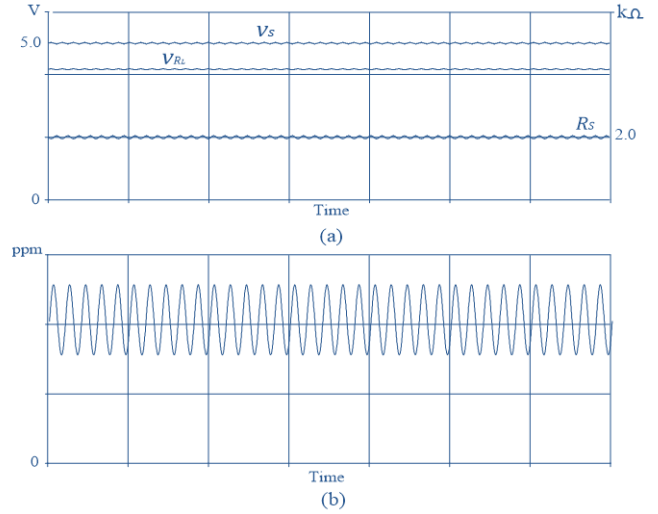

Fig. 2 Effect of ripple voltage on gas measurement: (a) $V_s + v_r \sin \omega_r t$, v_{R_L} and R_s (b) Gas concentration ppm

2.3. Gas Measurement with Ripple Voltage

The process of determining the R_s value and converting it to ppm gas volume occurs under a stable voltage source of 5.0 V, albeit with some inherent discrepancies. The primary challenge lies in sustaining a consistent 5.0 V source voltage. It's worth noting that the sensitivity of the sensor circuit is characterized by the ratio of v_{R_L} and the range's magnitude to the corresponding change in gas concentration magnitude denoted as mv/ppm [9]. This implies that minor fluctuations in the output voltage significantly affect the accuracy of gas measurements. In the scenario where the supply voltage contains ripple voltage ($v_s = V_s + v_r \sin \omega_r t$), Equation (1) can be reformulated as follows.

$$v_{R_L} = \frac{(R_L \cdot (V_s + v_r \sin \omega_r t))}{(R_s + R_L)} \quad (4)$$

Based on the outcomes of Equation (4), it is evident that the output voltage experiences fluctuations corresponding to the ripple voltage. Consequently, the determination of the R_s value, as outlined in Equation (2), fluctuates accordingly, thereby affecting the gas volume determination extended by Equation (3). Figure 2 illustrates the impact of ripple voltage on gas volume accuracy. In Figure 2(a), the supply voltage of $V_s = 5.0 \text{ V}$ is depicted with added ripple voltage, $v_r \sin \omega_r t$ showcasing the voltage drop across the load, v_{R_L} and sensor resistance, R_s . Figure 2(b) illustrates the gas volume, where the magnitude of its deviation is influenced by the ripple voltage and the level of gas content is determined by the ratio of R_s/R_0 .

3. Mitigating Ripple Voltage effects on Gas Measurement

The accuracy of gas quantity is significantly affected by the ripple voltage of the power supply. To mitigate these effects, simple techniques such as low-pass filtering and feed-forward techniques can be employed effectively.

3.1. Gas Measurement System

As shown in Figure 3(a), the presence of a ripple voltage alongside the DC voltage in the power supply can significantly affect measurement accuracy. To address this issue, low-pass filtering techniques are employed to eliminate the ripple voltage. Figure 3(b) illustrates various options that can address ripple voltage, such as using an analog low-pass filter circuit at the v_{RL} , or using digital filtering, which can be implemented either at the v_{RL} stage or after gas volume calculation. In our study, we opted for post-calculation filtration to facilitate comparison between pre- and post-filter gas quantities. The simple digital low-pass filter equation in a first-order form with feedforward is represented as:

$$y[n] = a_1y[n - 1] + b_0x[n] + b_1x[n - 1] \quad (5)$$

Here, $y[n]$ denotes the current output signal, $y[n - 1]$ is the previous output signal, $x[n]$ represents the current input signal, $x[n - 1]$ represents the previous input signal, and a_1 , b_1 , and b_0 are the filter coefficients [10]-[11].

3.2. Feedforward Technique

To mitigate the impact of ripple voltage on measurement accuracy, the voltage from the power supply serves as a reference, as shown in Figures 3(a) and (c), is reduced according to the following ratio:

$$v_f = \frac{V_s + v_r \sin \omega_r t}{2} \quad (6)$$

A feed-forward voltage v_f is supplied to the microcontroller, which is then converted into a 10-bit digital signal and further transformed into an analog voltage by multiplying it by two. As a result, we obtain a voltage equivalent to the power supply voltage. Consequently, we can directly determine the voltage drop across R_s . Therefore, it can be calculated as follows.

$$R_s = \left(\frac{(V_s + v_r \sin \omega_r t) - v_{RL}}{v_{RL}} \right) \cdot R_L \quad (7)$$

To illustrate the efficacy of the proposed technique in attenuating the ripple voltage, let's assume that the voltage drop across the load v_{RL} is attenuated by a factor k .

$$v_{RL} = \frac{R_L}{R_s + R_L} \cdot (V_s + v_r \sin \omega_r t) = k \cdot (V_s + v_r \sin \omega_r t) \quad (8)$$

Substituting Equation (8) into Equation (7) yields the following expression:

$$R_s = \frac{(1-k)}{k} \cdot R_L \quad (9)$$

Equation (9) demonstrates that the value of R_s remains independent of the power supply voltage, indicating the efficacy of the proposed technique in mitigating the impact of ripple voltage.

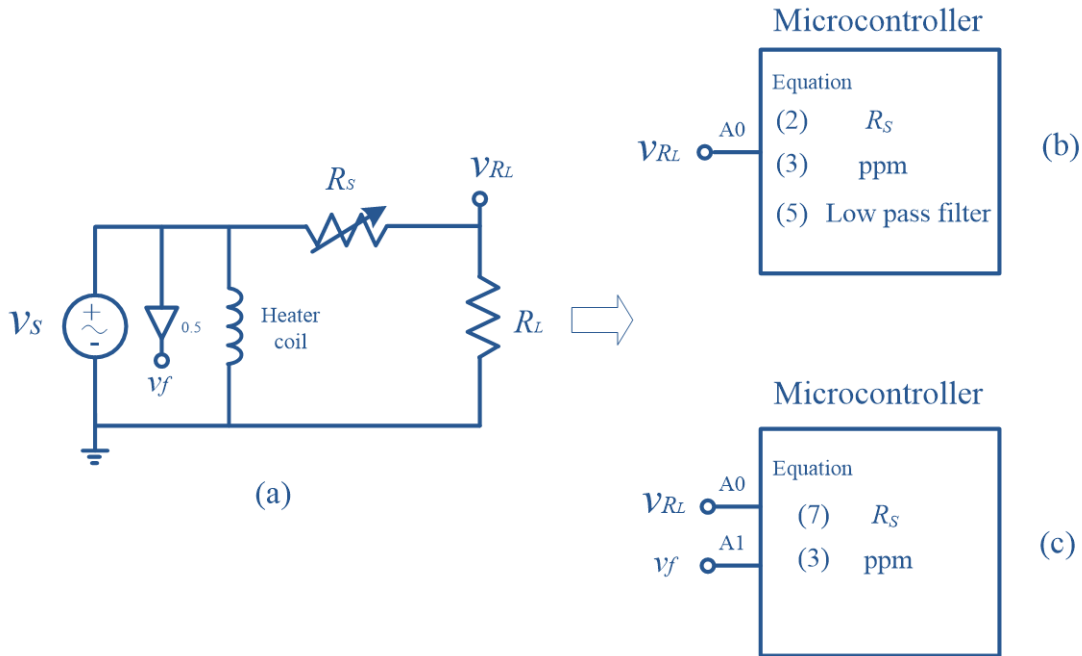

Fig. 3 Mitigating ripple voltage on gas measurement: (a) Equivalent circuit with ripple voltage (b) Low pass filter and (c) Feedforward technique

Table 1. Coefficients of power curve fitting of MQ-4

MQ sensors	Gases	Scaling coefficient a	Exponent or power b
MQ-4	CH ₄	1012.7	-2.786
R ₀ = 4.95 kΩ	LPG	3811.9	-3.113
	H ₂	277,743	-5.401

4. Simulation Results

This section presents a simulation conducted using PSPICE to compare the results with traditional methods. The simulation involves employing a low-pass filter circuit and a feed-forward technique.

4.1. Simulation Setup

Table 1 presents the coefficients derived from the power curve fitting equation used for an example MQ4 sensor. These coefficients were calculated using an Excel program, while the R_0 value was obtained through experimentation. The table provides critical parameters for accurate gas detection using the MQ4 sensor. Figure 4 depicts models in the PSPICE program. Figure 4(a) illustrates a model for gas measurement employing the traditional method, which is enhanced for accuracy through a low-pass filter, first order with a cutoff frequency of 5 Hz. This filtering technique helps to eliminate high-frequency noise, improving the precision of the measurements. Conversely, Figure 4(b) portrays a model of the proposed method, which incorporates advanced techniques for better performance. Both models utilize the interpolation coefficients derived from the power curve fitting equation in Table 1 to measure LPG gas. The comparison of these models highlights the improvements and potential advantages of the proposed method over the traditional approach.

4.2. In case of Power Supply Voltage Variation

In practice, deviations in the voltage source are common occurrences. To simulate this scenario, the supply voltage was

intentionally set to deviate by ± 0.05 V, with $v_r = 0$ V and $R_0 = 4.95$ k Ω . As shown in Figure 5, the simulation results illustrate the impact of these deviations.

When the supply voltage deviates from the normal 5.0 V, the gas concentration calculations based on Equations (1), (2), and (3) become inaccurate. This discrepancy becomes more pronounced as the deviation from the ideal 5.0 V supply voltage increases. The experimental results show that even a small deviation in the power supply voltage can lead to significant errors in gas concentration measurements, highlighting the importance of stable power supply conditions for accurate sensor readings. For example, consider the sensor resistance $R_s = 4.95$ k Ω , when the supply voltage is at the ideal 5.0 V, the calculated LPG gas concentration is 3,810 ppm. However, if the supply voltage drops slightly to 4.95 V, the calculated LPG concentration decreases to 3,482 ppm. Conversely, if the supply voltage increases slightly to 5.05 V, the calculated LPG concentration rises to 4,138 ppm. These results illustrate how even minor deviations in the supply voltage can lead to significant variations in the measured gas concentration. This sensitivity underscores the importance of maintaining a stable supply voltage to ensure accurate gas detection and measurement.

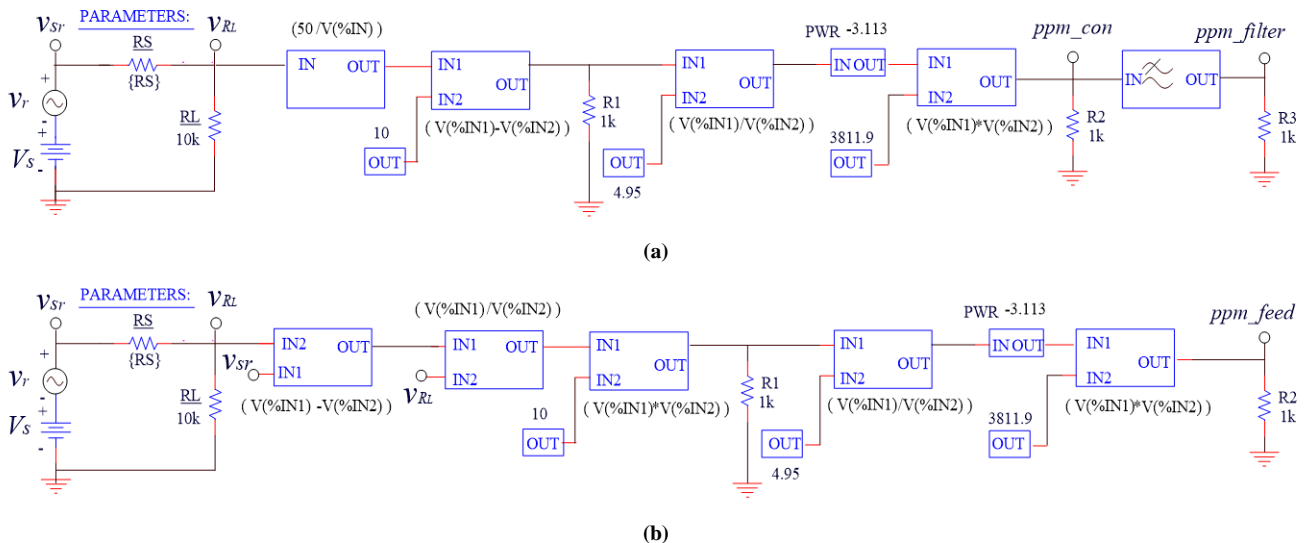

Fig. 4 Simulation models by PSPICE (a) Conventional with low pass filtering technique (b) Feed-forward technique

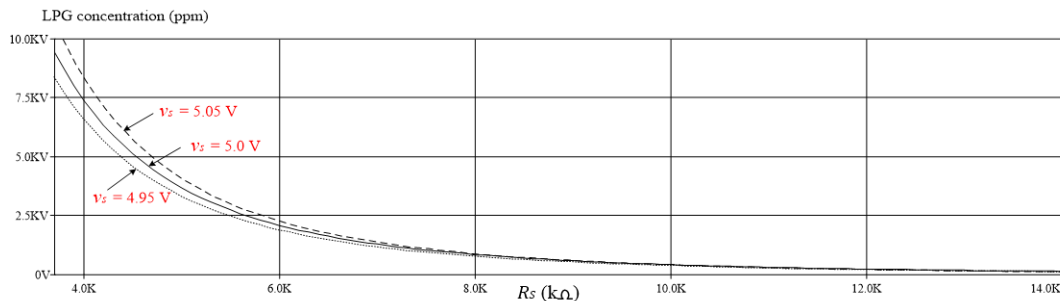

Fig. 5 LPG gas concentration, ppm, versus sensor resistance in case various power supply voltage

4.3. In case of Ripple Voltage

Figure 6 depicts the simulation results with $V_s = 5.0\text{ V}$, $v_r = 20\text{ mV}$, $f_r = 10\text{ kHz}$, and $R_s = 4.95\text{ k}\Omega$. From the simulation outcomes, it is evident that the gas volume results obtained using the traditional method, ppm_con , fluctuate with the magnitude of the ripple voltage, ranging from a maximum of 3,950 ppm to a minimum of 3,670 ppm. Conversely, with low-pass filtering, this effect can be mitigated, as shown by the gas volume, ppm_filter .

However, another consideration to be mindful of is phase implications. These issues can be addressed by the proposed method, where the gas volume remains constant at 3,810 ppm and is unaffected by ripple voltage, as observed in ppm_feed . Figures 7 and 8 depict the results when the source

voltage v_s deviates to 4.95 V and 5.05 V, respectively, combined with a ripple voltage $v_r = 20\text{ mV}$. From the simulation results, it can be observed that the gas volume obtained using the traditional method oscillates according to the magnitude of the ripple voltage.

Although employing a low-pass filter helps mitigate this oscillation, the gas content still exhibits deviations due to supply deviation, resulting in gas volumes of 3,460 ppm and 4,180 ppm, respectively. These effects are rectified using the feed-forward technique by taking the supply voltage as a reference. This enables the calculation of a constant sensor resistance, $R_s = 4.95\text{ k}\Omega$, resulting in a constant gas volume of 3,810 ppm, which remains independent of the source voltage v_s and the ripple voltage, v_r .

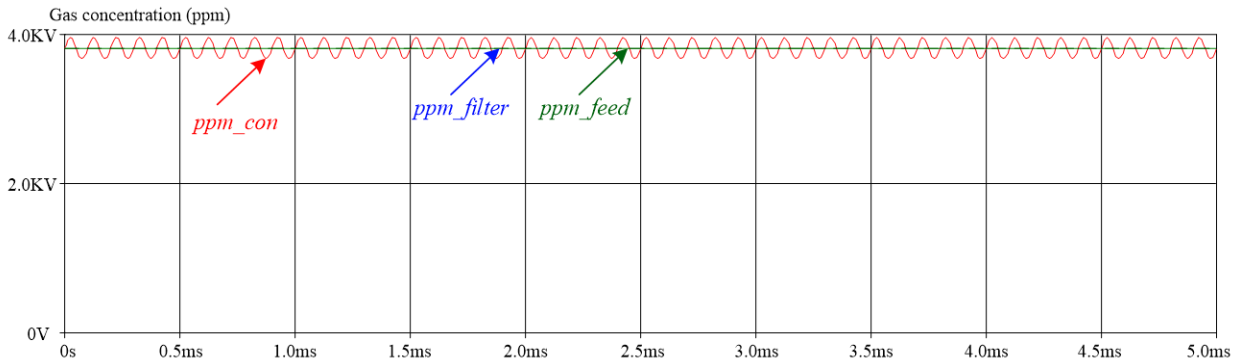

Fig. 6 LPG gas concentration, ppm, in case of $V_s=5.0\text{ V}$, $v_r=0.02\text{ V}$, $f_r=10\text{ kHz}$

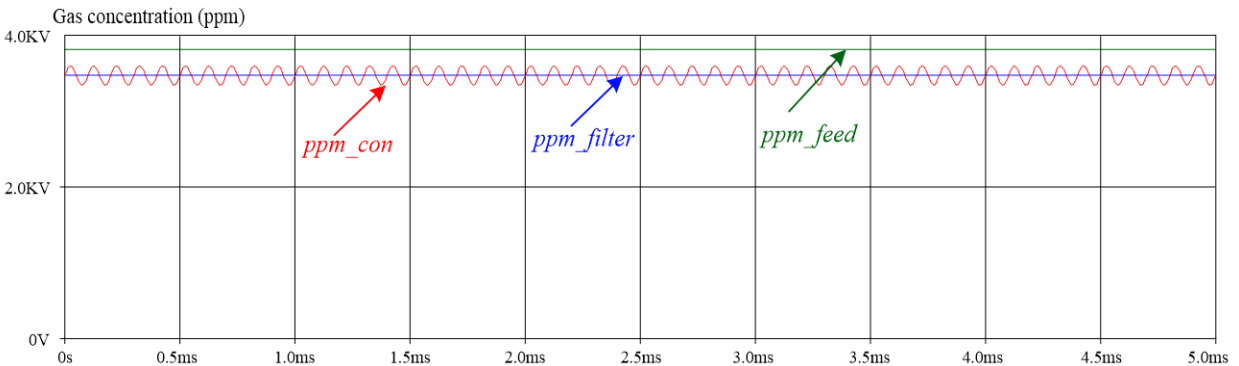

Fig. 7 LPG gas concentration, ppm, in case of $V_s = 4.95\text{ V}$, $v_r = 0.02\text{ V}$, $f_r = 10\text{ kHz}$

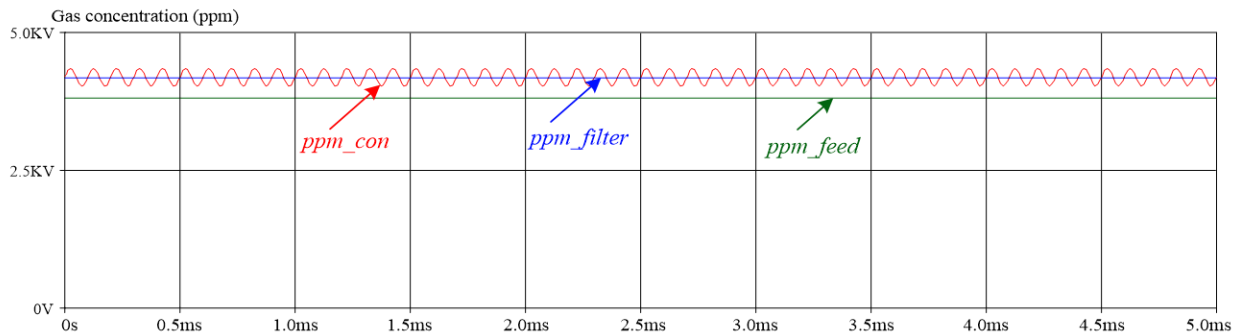

Fig. 8 LPG gas concentration, ppm, in case of $V_s = 5.05\text{ V}$, $v_r = 0.02\text{ V}$, $f_r = 10\text{ kHz}$

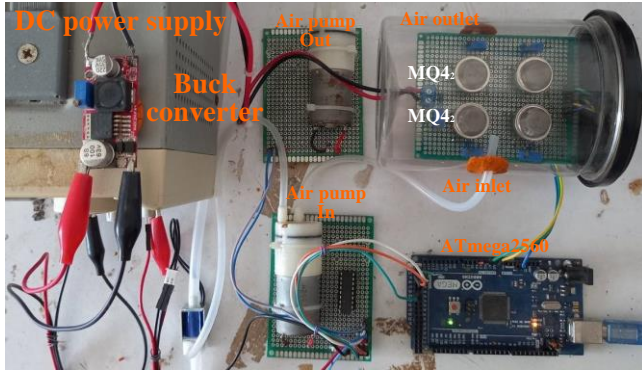

Fig. 9 Experimental setup

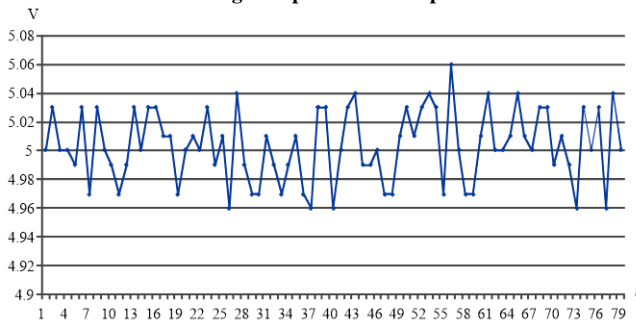

Fig. 10 Ripple voltage fluctuations displayed on the screen via the serial port

5. Experimental Results

This section presents the outcomes of gas measurement experiments conducted using a switching power supply, comparing the effectiveness of low-pass filtering techniques and feed-forward techniques in mitigating the effects of ripple voltage.

5.1. Experimental Setup

The experimental setup, depicted in Figure 9, comprises an Arduino Mega 2560 microcontroller board, 10 bits of ADC and clock frequency, 16 MHz linked to a PC via a USB port, air pump outlets, air pump inlets, buck converter, and four MQ-4 sensors fitted with $R_L = 10 \text{ k}\Omega$ and divider resistors for power voltage sensing, all housed within a chamber. The gas measurement procedure involves the following steps:

- 1) Commence the air evacuation process using a pump.
- 2) Subsequently, introduced air is mixed with gas into the chamber using another pump.
- 3) Measure the gas concentration and monitor the results on the screen via the serial port.

5.2. In Case of Fluctuations in the Ripple Voltage of the Power Supply

For this experiment, a buck converter is utilized as the Switching Power Supply. Figure 10 displays the voltage output of the buck converter via the Arduino IDE monitor, which is configured to 5.0 V. However, it is evident that the voltage oscillates in accordance with the frequency of the converter. This fluctuation in ripple voltage can impact the accuracy of the measurement. However, the conversion of the analog signal by

the microcontroller takes approximately $100 \mu\text{s}$ [12], introducing a time delay between measuring the voltage at the power supply using Equation (6) and measuring the voltage across the load using Equation (4). This delay leads to a discrepancy in the measured values. To mitigate this effect, the research employs low-pass filtering after calculating R_s from Equation (7).

Figure 11 presents the gas measurement outcomes obtained from three different methods in the absence of LPG. The traditional method, employing Equations (1)-(3) for gas volume determination, exhibits significant fluctuations in gas volume values ranging from ppm_{con} , 21.12 to 24.94 ppm, corresponding to the supply ripple voltage. On the other hand, employing low-pass filtering with a cut-off frequency set at 30 Hz and filter coefficients of $a_1 = 0.828$, $b_1 = 0.0861$ and $b_0 = 0.0861$ results in a narrower range of gas volume swings, ranging from ppm_{filter} , 22.71 to 23.24 ppm. Notably, this technique effectively mitigates the impact of high-frequency ripple voltage. Moreover, the proposed method, which integrates voltage from the supply into the gas quantification process alongside low-pass filtering with a 30 Hz cut-off frequency, demonstrates even tighter gas volume oscillations within the range of ppm_{feed} , 22.53 to 22.93 ppm.

Figure 12 illustrates the gas measurement outcomes when the supply voltage decreased to 4.9 V, impacting the accuracy of gas quantity determination. With the conventional method, the gas content, represented by ppm_{con} , exhibits a wide range of swings from 13.62 to 15.81 ppm. In contrast, employing the digital filter technique results in narrower gas content fluctuations, ranging from ppm_{filter} , 14.72 to 14.76 ppm, with an average of approximately 14.74 ppm. Notably, this average is lower than that observed when the supply voltage is 5.0 V. In the proposed method, gas volume fluctuations are confined within a narrow range of ppm_{feed} , 16.89 to 17.09 ppm.

Figure 13 presents the comparative measurement results of the three methods when the supply voltage drops to 5.1 V. In this scenario, the proposed method yields an average gas content of approximately 30.5 ppm, lower than both the conventional method and the digital filter technique. While slight differences exist in gas content values among the three methods, it is evident that traditional methods and the use of low-pass filters exhibit higher inaccuracies, particularly as gas volume increases. From the test results, it is evident that variations in the supply voltage to $V_s = 4.9$ and 5.1 V lead to corresponding changes in the gas volume as per the proposed method. Theoretical analysis and simulation corroborate that the gas volume remains consistent despite fluctuations in the supply voltage, ideally stabilizing at 23 ppm. However, when the supply voltage deviates to $V_s = 4.9$ and 5.1 V, which also powers the heating coil, the internal sensor temperature fluctuates accordingly, impacting the gas volume stability of the proposed method.

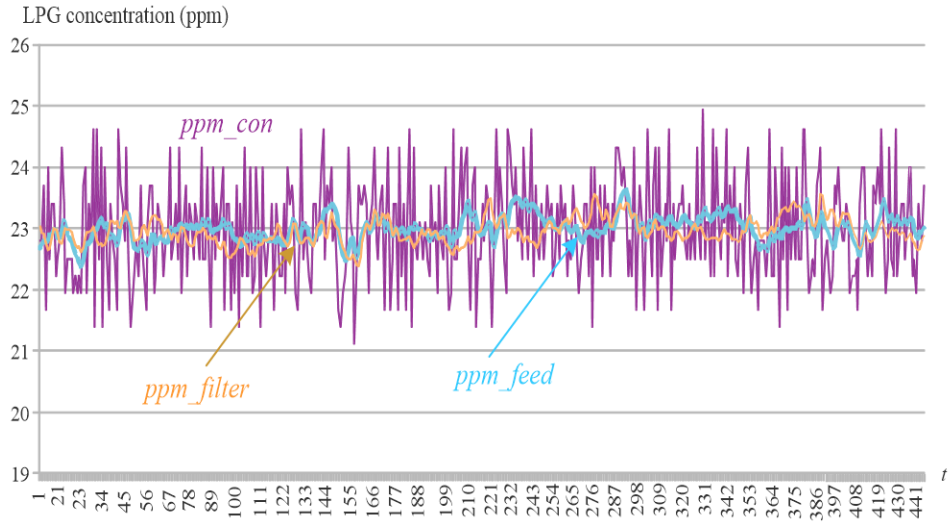

Fig. 11 LPG concentration, ppm, in case of $V_s = 5.0$ V with ripple voltage effect

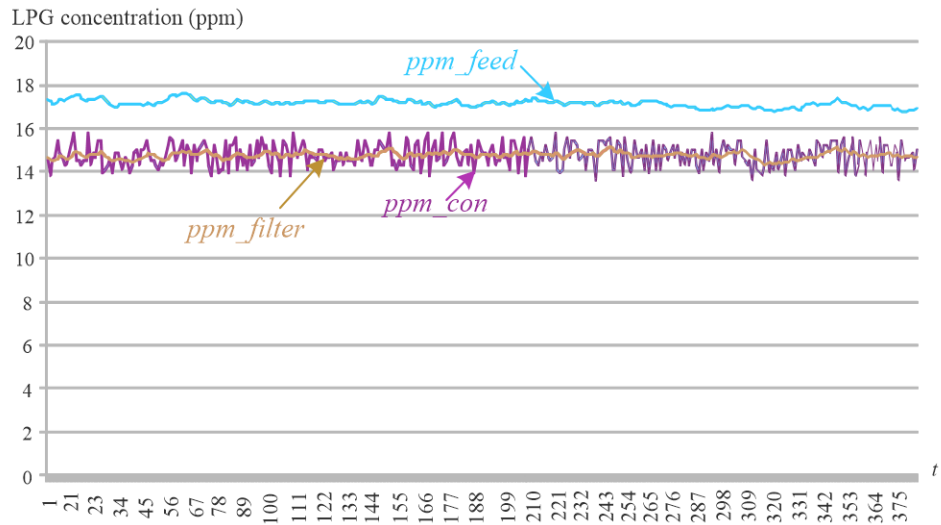

Fig. 12 LPG concentration, ppm, in case of $V_s = 4.9$ V with ripple voltage effect

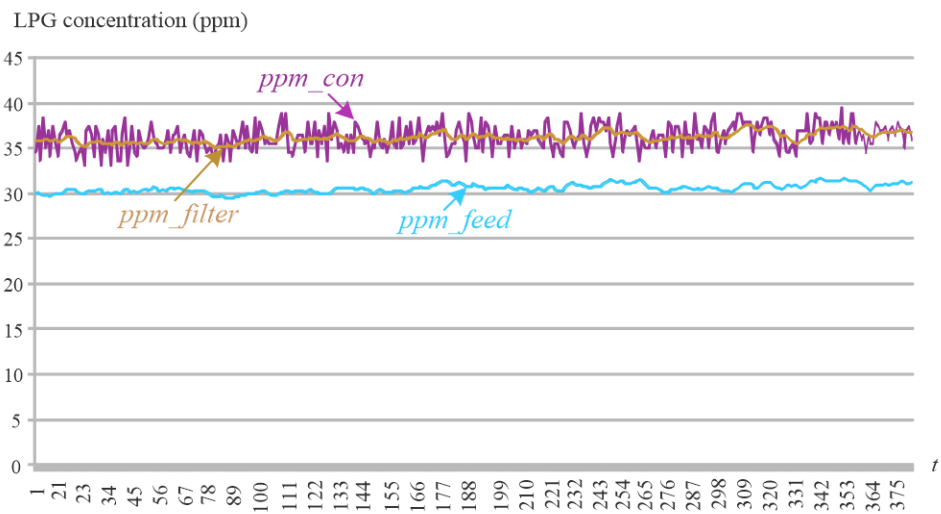

Fig. 13 LPG concentration, ppm, in case of $V_s = 5.1$ V with ripple voltage effect

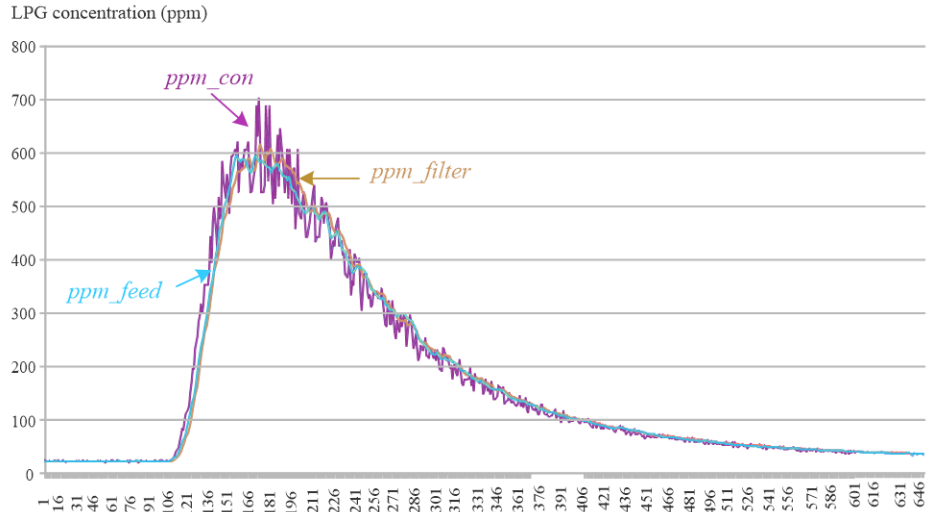

Fig. 14 Response LPG concentration, ppm, $V_s = 5.0$ V with ripple voltage

Nevertheless, the gas volume fluctuation observed with the proposed method is comparatively lower than that of the traditional method and low-pass filtering. To enhance gas quantity accuracy, temperature compensation techniques can be employed based on the information provided in the datasheet [1]-[2].

5.3. Response of Gas Measurements

This experiment underscores the phase effect of low-pass filtering when LPG gas is introduced into the measurement system. Figure 14 depicts the step response of MQ-4 sensors using three distinct gas measurement methods. Notably, the traditional method displays a quicker response compared to both low-pass filtering methods, which exhibit a noticeable phase lag. While low-pass filtering can yield accurate and smooth gas volume measurements, selecting a low cutoff frequency amplifies the phase lag. Consequently, when applying the proposed method for gas measurement, careful consideration of these effects is essential, particularly concerning accuracy and measurement response sensitivity.

6. Discussion

The findings of this study shed light on the critical role of power supply stability in gas measurement accuracy, particularly concerning MQ series and TGS family gas sensors. The analysis revealed that deviations in the power supply voltage can significantly impact the precision of gas volume calculations. Linear power supplies, although commonly used, are susceptible to temperature and long-term stability issues, leading to voltage discrepancies, especially when supplying high currents for sensor arrays. The proposed approach employs a combination of low-pass filtering and feed-forward techniques to minimize the impact of ripple voltage on gas measurement accuracy. Simulation results demonstrated that these techniques effectively mitigate the oscillations in gas volume caused by ripple voltage

fluctuations. Specifically, low-pass filtering reduced the oscillations, while the feed-forward technique utilizing the supply voltage as a reference enabled consistent gas volume calculations regardless of ripple voltage variations. However, only the MQ family of sensors was tested in this study. Although the TGS family of sensors has a similar structure, it should also be evaluated to confirm the findings. Additionally, errors arising from the microcontroller's ADC process—such as gain, offset, quantization, Integral Non-Linearity (INL), and Differential Non-Linearity (DNL) errors—should be taken into consideration for a comprehensive analysis.

7. Conclusion

In conclusion, this research investigated the impact of ripple voltage on the accuracy of gas measurements and proposed techniques to mitigate its effects. The study revealed that deviations in power supply voltage can lead to significant inaccuracies in gas volume calculations, highlighting the importance of addressing ripple voltage fluctuations in gas measurement systems. Through a combination of low-pass filtering and feed-forward techniques, the proposed method effectively minimized the oscillations in gas volume values caused by ripple voltage fluctuations. Simulation and experimental results demonstrated the superior stability and accuracy of the proposed method compared to traditional approaches and low-pass filtering techniques. Overall, this study contributes to advancing the field of gas measurement by providing a robust methodology to enhance measurement accuracy in the presence of power supply fluctuations. Future research could explore additional techniques or optimizations to further improve the resilience of gas measurement systems to ripple voltage effects and expand their applicability in diverse real-world scenarios.

Acknowledgments

This research project was financially supported by Mahasarakham University.

References

- [1] MQ Series Gas Sensor, Robu, 2020. [Online]. Available: <https://robu.in/mq-series-gas-sensor/>
- [2] Gas Sensors & Modules, Figarosensor. [Online]. Available: <https://www.figarosensor.com/product/sensor/>
- [3] Hussein J. Khadim, Faik K. Obaed, and Ziad T. Abd Ali, "Application of MQ-Sensors to Indoor Air Quality Monitoring in Lab based on IoT," *International Conference on Intelligent Technology, System and Service for Internet of Everything (ITSS-IoE)*, Sana'a, Yemen, pp. 1-5, 2021. [[CrossRef](#)] [[Google Scholar](#)] [[Publisher Link](#)]
- [4] Mochamad Irwan Nari et al., "The Portable Carbon Monoxide (CO) and Hydrocarbons (HC) Gas Detection System in the Car Cabin Uses the MQ-9 and TGS 2610 Sensors," *Indonesian Journal of Engineering Research*, vol. 2, no. 1, pp. 12-17, 2021. [[CrossRef](#)] [[Google Scholar](#)] [[Publisher Link](#)]
- [5] LM317 3-Terminal Adjustable Regulator, Texas Instruments Incorporated, pp. 1-31, 2023. [Online]. Available: <https://www.ti.com/lit/ds/symlink/lm317.pdf>
- [6] Rich Nowakowski, and Robert Taylor, "Linear Versus Switching Regulators in Industrial Applications with A 24-V," *Analog Applications Journal*, pp. 1-7, 2013. [[Google Scholar](#)] [[Publisher Link](#)]
- [7] Shoffi Izza Sabilla, Riyanarto Sarno, and Joko Siswantoro, "Estimating Gas Concentration using Artificial Neural Network for Electronic Nose," *Procedia Computer Science*, vol. 124, pp. 181-188, 2017. [[CrossRef](#)] [[Google Scholar](#)] [[Publisher Link](#)]
- [8] Dedy Rahman Wijaya, Riyanarto Sarno, and Enny Zulaika, "Gas Concentration Analysis of Resistive Gas Sensor Array," *2016 International Symposium on Electronics and Smart Devices (ISESD)*, Bandung, Indonesia, pp. 337-342, 2016. [[CrossRef](#)] [[Google Scholar](#)] [[Publisher Link](#)]
- [9] A.T. Ajiboye et al., "Analytical Determination of Load Resistance Value for MQ-Series Gas Sensors: MQ-6 as Case Study," *TELKOMNIKA Telecommunication, Computing, Electronics and Control*, vol. 19, no. 2, pp. 575-582, 2021. [[CrossRef](#)] [[Google Scholar](#)] [[Publisher Link](#)]
- [10] Miroslav Matejček, and Mikuláš Šostronek, "Low-Pass Filter Design with Microcontroller," *2022 New Trends in Signal Processing (NTSP)*, Liptovský Mikuláš, Slovakia, pp. 1-8, 2022. [[CrossRef](#)] [[Google Scholar](#)] [[Publisher Link](#)]
- [11] Curiores, Arduino Tutorials, 2022. [Online]. Available: <https://github.com/curiores/ArduinoTutorials/tree/main/BasicFilters/ArduinoImplementations/LowPass/SimpleExamples>
- [12] AnalogRead(), Arduino, 2023. [Online]. Available: <https://www.arduino.cc/reference/en/language/functions/analog-io/analogread/>