

Original Article

# A Novel Design of Smart Electric Powered Wheelchair using IoT

K. Kittiphunworakul<sup>1</sup>, B. Maungmeesri<sup>2</sup>, D. Maneetham<sup>3</sup>

<sup>1,2</sup> Industrial of Technology Faculty, Valaya Alongkorn Rajabhat University, Thailand

<sup>3</sup> Mechatronics Engineering, Rajamangala University of Technology Thanyaburi, Thailand

korn.kit@vru.ac.th

Received: 28 March 2022

Revised: 26 May 2022

Accepted: 30 May 2022

Published: 27 May 2022

**Abstract** - The internet is now increasingly essential in everyday life. The Internet allows people to receive and send a vast range of information. The Internet may be used in various ways to get the most out of it nowadays. The concept of the Internet of Things, for example, implies that everything is connected to the Internet. Allowing humans to control the operation of various equipment over the Internet, such as turning on and off gadgets, electrical appliances, communication tools, agricultural tools, and household appliances in daily life via the network, the Internet, and so on. The notion of a smart electric-powered wheelchair is based on the Internet of Things. Electrical appliances, services, monitoring, and access to control numerous devices are connected through residential communication networks. The controls may be monitored and operated from the power wheelchair anytime. A smart cart's construction must include three basic components: the first is a smart device that connects to it, the second is the Internet network, and the third is the microcontroller. The results of this test allow the electric-powered wheelchair to be controlled remotely. Excellent command and control. Most importantly, it has a high level of security for users.

**Keywords** - Electric Powered Wheelchair, Computer Control, Monitoring, IoT.

## 1. Introduction

Thailand is currently transitioning into an aging society, with an increasing number of seniors each year. Thailand's population is 66,188,503 individuals, according to the Department of Provincial Administration's registration data system. The aged will confront health issues with 15% of the old, or around 10-11 million people out of the total population. Poor eyesight, deteriorating joints, uncomfortable walking, high blood pressure, diabetes, and an increasing propensity to be alone are all symptoms of aging. Because the children are required to work outside the home, another issue is the elderly face [14],[16]. When you're lonely, you rarely get to talk to other people, such as neighbors, community members, or society members. It will be something that will aid in the happiness and health of the elderly. Some elderly adults will be unable to walk without assistance. Require the use of a wheelchair To travel to the desired location, such as around the house, in the village, or beyond. Wheelchairs and electric wheelchairs are the two most common forms of wheelchairs. Which wheelchair is a wheelchair that requires a wheelchair and the use of a wheelchair to move the wheelchair in the manual movement of the wheelchair, causing the elderly to exert himself to move, causing the elderly to feel tired, which will directly

affect the elderly's overall health? The electric wheelchair will have the same features and functions as a wheelchair but will be powered by electricity, allowing the old to avoid exerting themselves.

However, the price will be very costly, which impoverished families cannot afford, especially in the current economic climate. The fast spread of the Internet network, combined with technological advancements, has resulted in a booming electronic industry. As a result, the development of Internet of Things (IoT) devices has gotten a lot of attention [9],[10],[11], allowing monitoring and control to be done from anywhere with an Internet connection. Rely on a control system that provides feedback. CNC machines, robotics, water level management, pressure, and chemical processes are a few examples. As a result, embedded system algorithms are more sophisticated than stored tasks. In addition, using hardware that leverages random precision would inspire developers and researchers to construct gadgets that can be used efficiently in various jobs. As a result, the researcher devised a plan to create an autonomous wheelchair for the elderly with an all-encompassing system for those unable to move freely.



In addition, the wheelchair can be driven without the need for pushing or assistance. With an automatic wheelchair for the elderly, it's affordable. Elders can walk around with the help of a smartphone application, and wheelchairs for them are automatic. It is a gizmo that will make it easier for the elderly to get around. Traveling is simple and safe without the assistance of grandchildren or other family members who are now elderly. The majority of people are unable to walk with ease [7],[8]. In addition, the old family must squander time waiting for their offspring to assist and care for them. The senior might sometimes be a bit pushy because of arm muscle soreness; I couldn't push the cart too far. To aid in reducing the strength of some elderly folks who become weary easily because wheelchairs are normally propelled, they must be pushed by themselves or with assistance, which can be challenging. Some older persons disliked being in wheelchairs and wished to travel alone, resulting in an accident. Overall, wheelchairs are extremely beneficial in terms of accessibility, for autonomous carts for The elderly will be able to move safely both during the day and at night.

## 2. Research Method

### 2.1. Hardware Design

Using a motorized wheelchair also assists the sick, disabled, and aged. It is thought to have promise because it can direct by the motions of everyday life. Today's electric wheelchairs come in various styles, including lightweight electric wheelchairs. The electric wheelchair that folds, Electric wheelchairs that can be adjusted, and general electric wheelchairs. In which you can select the electric wheelchair model that best suits the user's demands. This motorized wheelchair Can run continuously for a total distance of 16-20 km, has 5-speed settings, can control speeds up to 6 km/h, can be converted from an electric wheelchair to a basic manual wheelchair, and can support up to 120 kg. Turn left, right, forward, and backward movement may be controlled.



Fig. 1 Smart electric-powered wheelchair

Equipment for the control system, the researcher employed a computer board with a Windows 10 operating system (minicomputer) and a display (eDP+ touch screen panel) to manage the device.

1. front-wheel-drive castor with 2 wheels, 10-inch diameter
2. 6-inch diameter rear-wheel-drive castors to control the movement; there are three sets of levers.
3. There are four movement directions (forward, rear, left, and right), and the chair may recline to 60 degrees
4. There are three levels of movement speed adjustment.
5. Motion control unit with microprocessor It was employed as a latte panda in this study.
6. Write control units in C Plus Plus (C++) or C Sharp (C#).
7. A collection of sensors for detecting a distance of at least 1 meter between the car and the object in front of it for the car to stop.
8. While the automobile is going, 8 sets of lamps and an LCD showing the battery status are displayed.
9. points for charging electricity in the automobile and an electric charger with a voltage of at least 24 volts and a current of at least 10 amps.
10. 24 volts 250 watts DC motor with built-in reduction gear 4 balls.
11. The DC motor driving unit is of the type (Mosfet Hybrid) with a size of at least 80 amps.

### 2.2. Microcontronller and Electronics Devices

Connection diagram for an electric wheelchair's control circuit A DC motor, a display, a microcontroller, a wifi receiver, and a DC motor driver are included. Figure 2 illustrates.

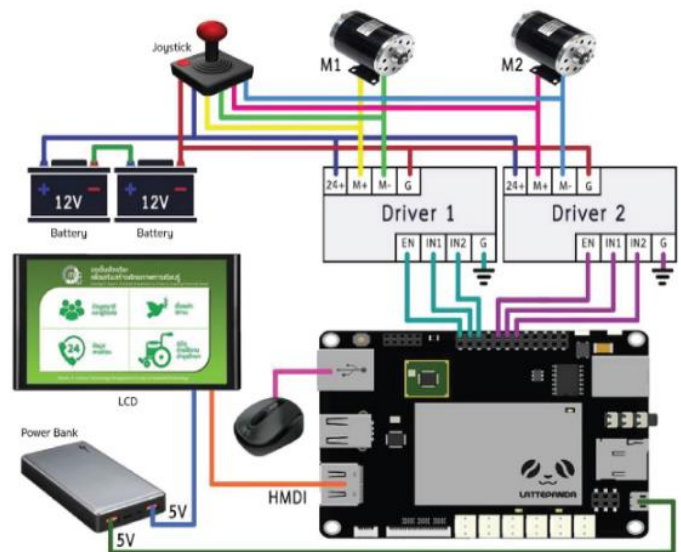

Fig. 2 Schematic of Control System

As shown in the picture, the point where the strain gauge receives a lot of pressure will cause the strain gauge to shrink together, and at the point of tension will cause the strain gauge to be stretched, causing the resistance value of the strain gauge to change. The four strain gauge on the load cell, as shown in the picture, then the point where the strain gauge receives a lot of pressure, is connected to the Wheatstone bridge circuit. The connection and operation inside the system of the autonomous wheelchair for the elderly with a microcontroller at the center of the system, which has two parts: input and output, are shown in Figure 2. The microcontroller must accept this section's data from sensors, smartphones, and emergency help buttons. The microcontroller will control the operation through the output. Featuring a motor and lighting controlled by a smartphone connected to the internet through Bluetooth. Design of an automatic cart The researcher designed by design using the analyzed data. Wheelchairs for the elderly operate automatically. The control section will have a total of two control functions. The part of the lighting control is as follows: mobile with a smartphone, and the part of the lighting control is as follows:

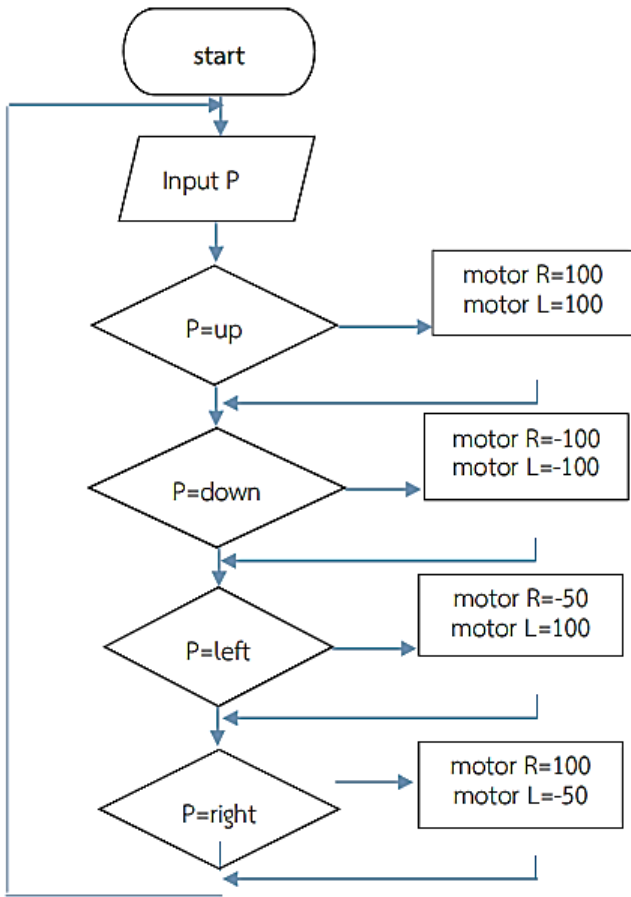

Fig. 3 The process demonstrates how to control a smartphone

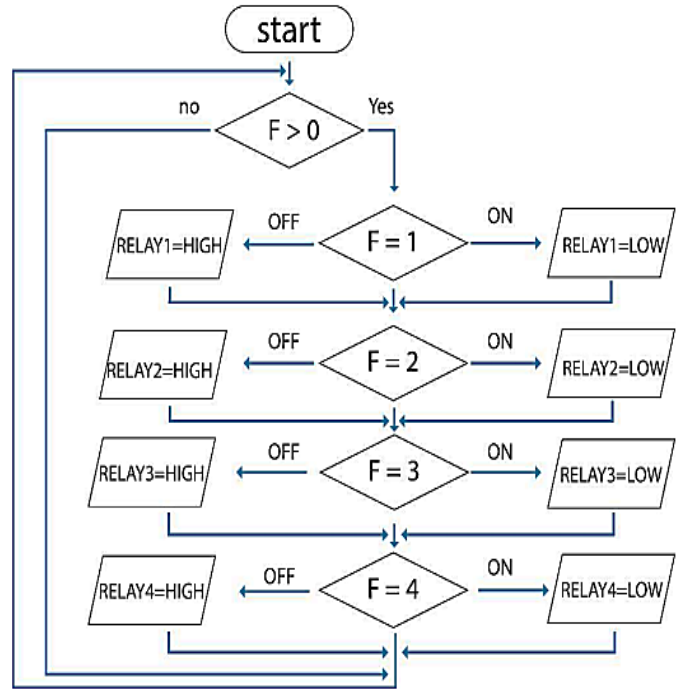

Fig. 4 Steps to demonstrate how to operate a lighting control system

The creation of an intelligent electric wheelchair is divided into three stages:

- 1) A software system is made up of programs and programming languages. 1) Make a plan. The Arduino IDE is a tool that allows you to write, compile, and upload programs to a microcontroller board. 2) The C++ language is an object-oriented (Object-Oriented Programming) language used to create smartphone user interfaces.

Anto is a communication tool. Anto provides you with a free service to use. It's similar to a communication medium for items on the Internet, such as You wish to use your mobile phone to control your microcontroller board through the Internet, for example. Our systems now support HTTP, HTTPS, MQTT, MQTTS, and WebSocket communication. It saves your team time during server installation, setup, and system maintenance.

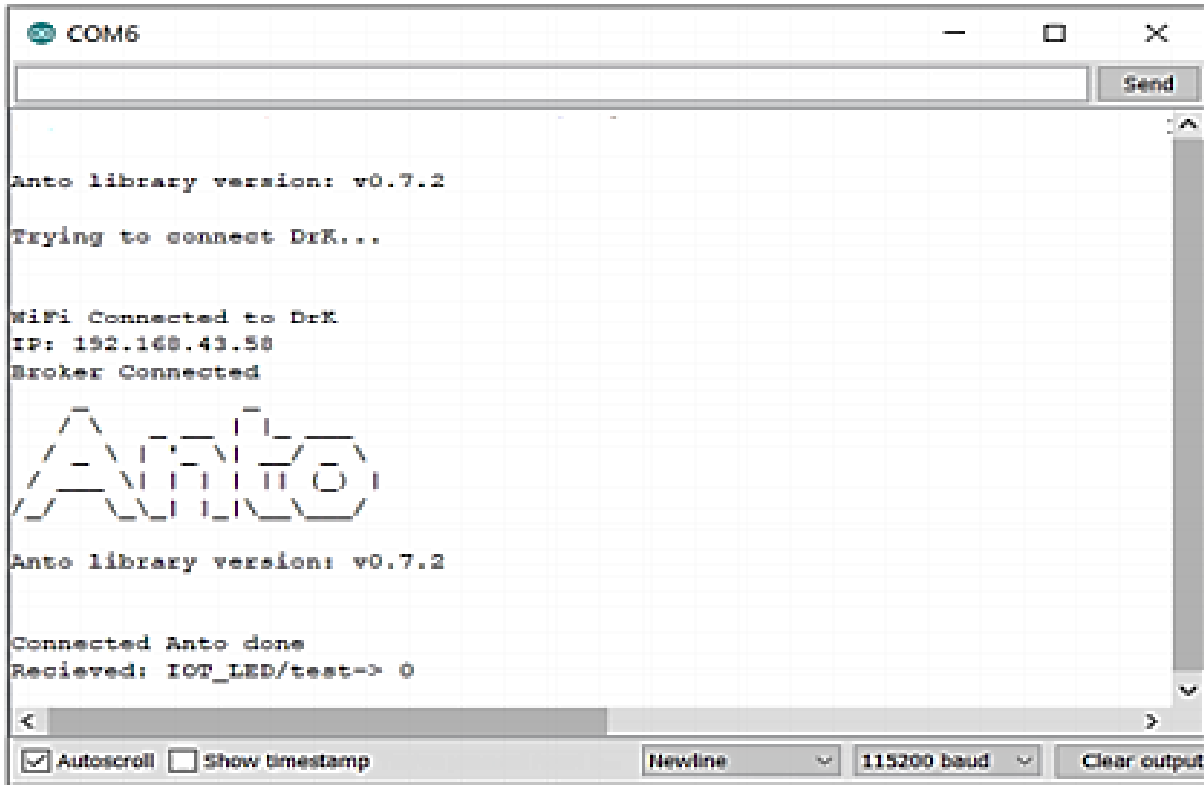

Fig. 5 Software connected with Anto.IO platform

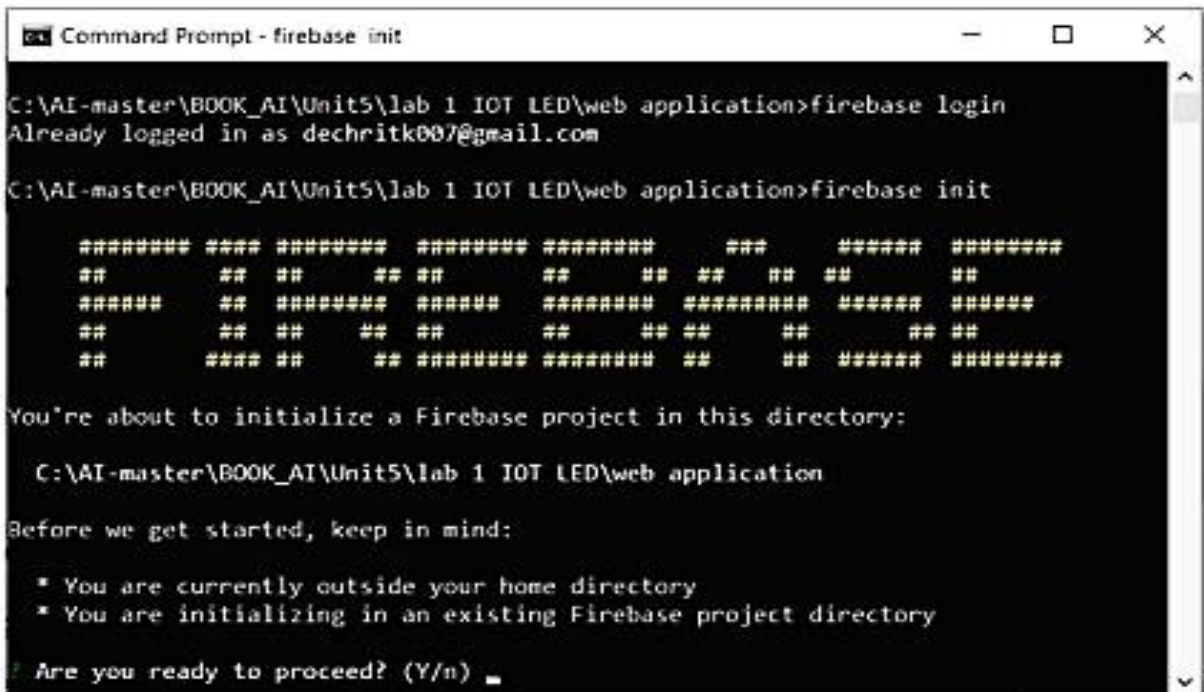

Fig. 6 Software connected with the firebase platform



Fig. 7 Touch Screen Main Menu



Fig. 8 Touch Screen users

2) Hardware system is made up of the following components:

- 1) Board Arduino Uno 32 KB (ATmega328), 16 MHz;
- 2) Board Arduino Uno 32 KB 2) H-Bridge DC BTS7960 6-27 volts, 47 amps
- 3) Motor: 24VDC, 350W, 19.2A,
- 4) 3.3 - 5V buzzer
- 5) Arcade Analog Joystick
- 6) 5V 4 Channel Relay Module
- 7) HC06 Bluetooth Module
- 8) wheelchair
- 9) A LED lamp
- 10) a battery and a charger
- 11) cell phone

## IOT Robot Control

### Distance

141

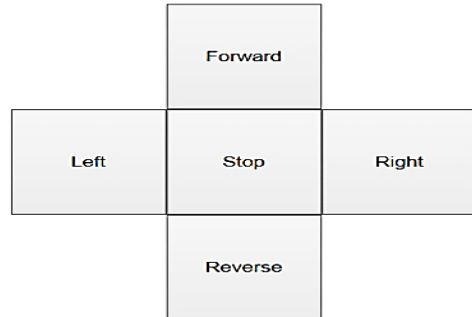

Fig. 9 IoT and Mobile Phone

This object represents the GUI screen of the smartphone application. It features a light-on/light-off switch. The forward, left, right, and reverse buttons are located in the center of the screen. The brake button is adjacent to the forward button, and Bluetooth, for example, is close to the back button in the lower-left corner.

3) GPS (Global Positioning System) The GDP Tracking System's working principle is that the device must be mounted on an electric wheelchair. The device will receive a signal from the GDP satellite to determine the car's location. The data is subsequently processed and sent to the operator center's computers over the cellular network in GPRS format. The location and information will be analyzed before being transferred to the client's computer for display on a digital map, and graphics or symbols represent the vehicle's status. The system can provide a report with critical information as requested by the service receiver.

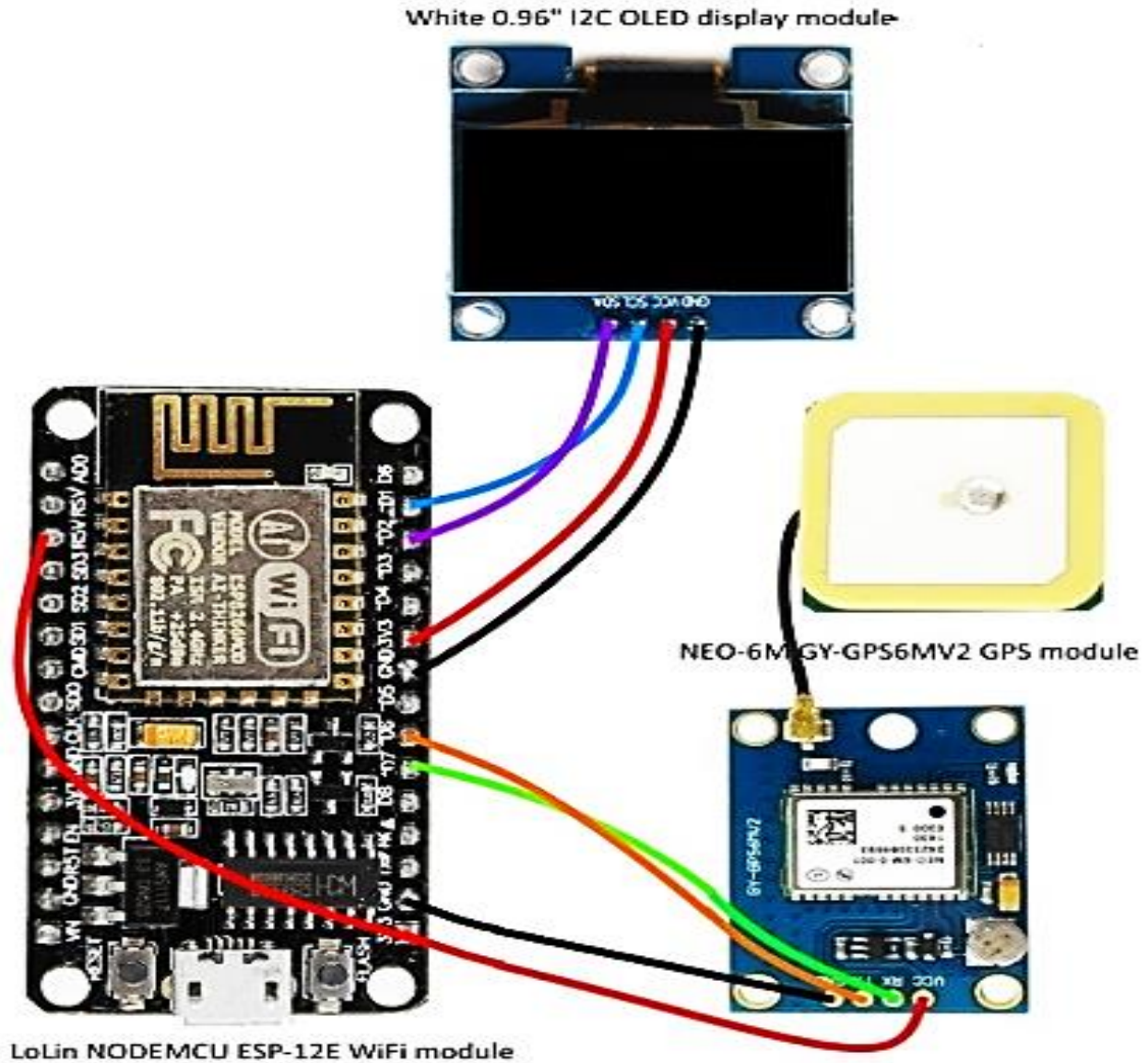

Fig. 10 ESP8266 and GPS Module

### 3. Experimental and Results

From the research on all-systems automatic wheelchair control for the elderly, The researcher looked into and developed automatic wheelchairs and measured how satisfied the elderly were with them once they were upgraded and used. Expert advice was used to improve and repair the flaws tested on the elderly. And a survey of 30 older folks was undertaken to gauge their satisfaction. The following are the study findings: The mobility experiment of automatic wheelchairs for the elderly to control their movement using an application managed via a smartphone was discovered during the study and development of automatic wheelchairs for the elderly. It can steer the wheelchair in the following directions: 1) The microcontroller in the front will control the left motor. On both sides, the right side rotates forward. 2) Reverse: the microprocessor will order the left and right motors to rotate in the opposite direction. 3) Turn right: the microcontroller will instruct the left motor to rotate forward and the right motor to reverse. 4) turn left. The microcontroller will tell the right motor to turn ahead and the motor to turn left. rearward turn to the left

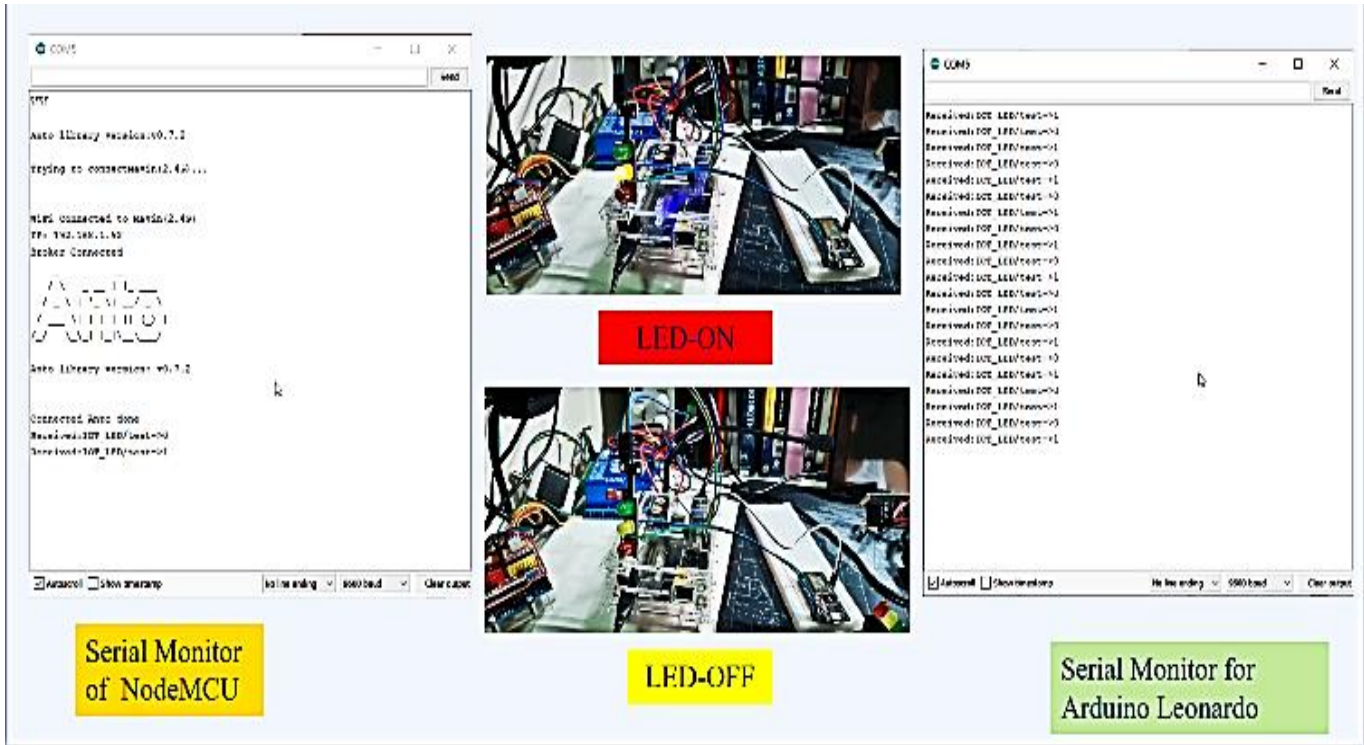

Fig. 11 Connection to Anto.IO

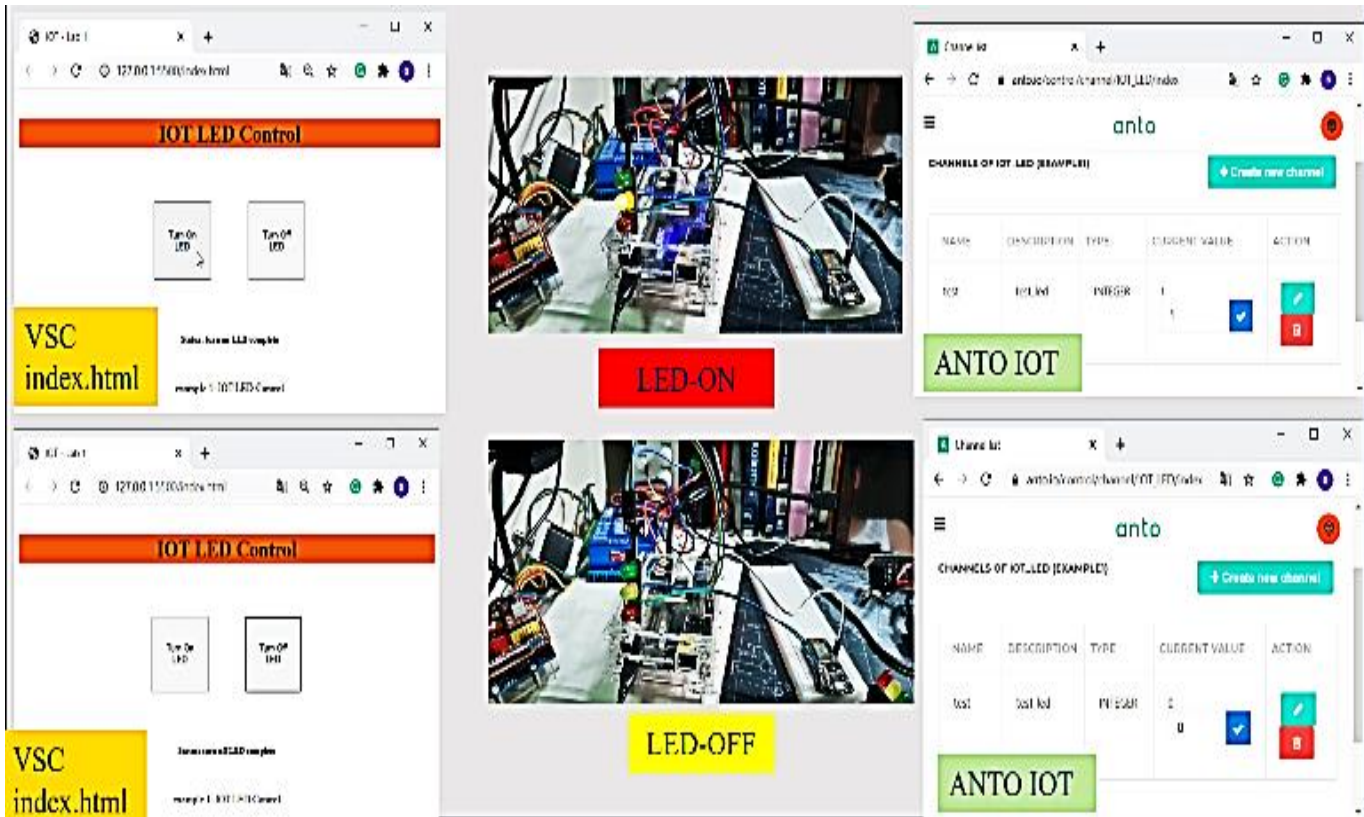

Fig. 12 Connection to Software

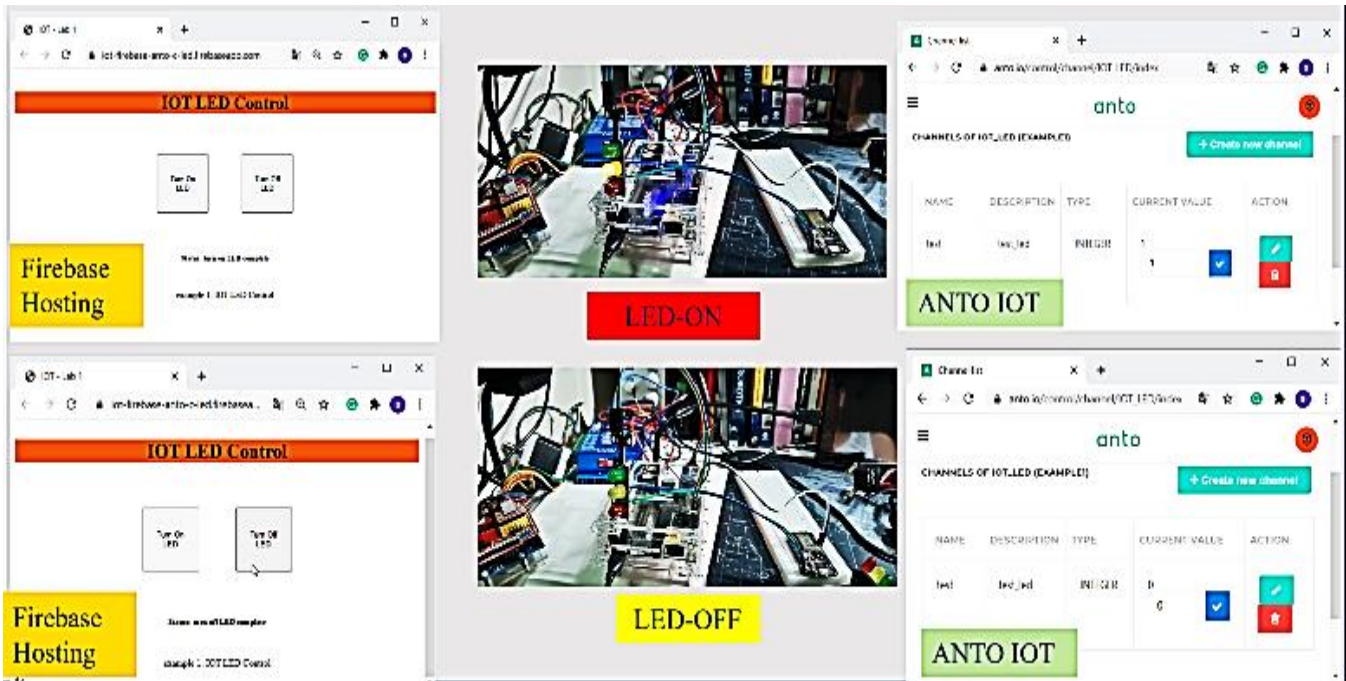

Fig. 13 Connection to Firebase

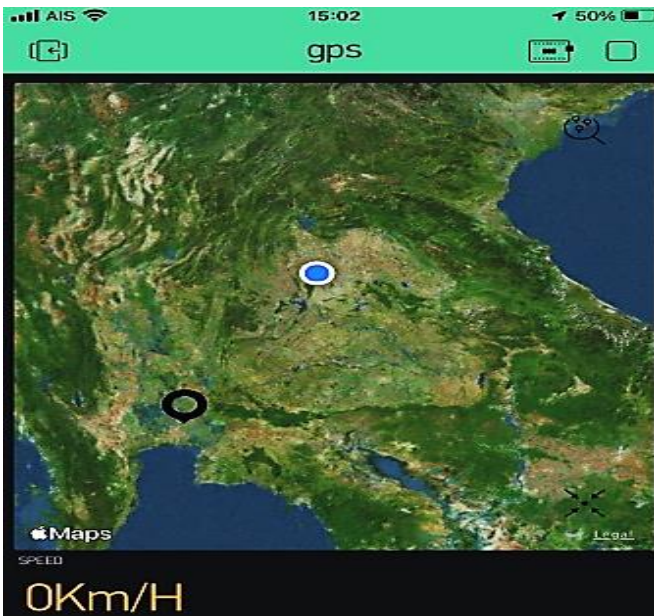

Fig. 14 GPS Starting point

wheelchair

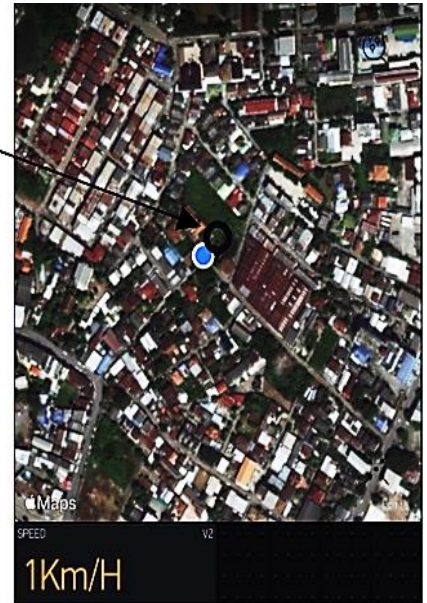

Fig. 15 GPS Position 1





Fig. 16 GPS Position 2



Fig. 17 GPS Position 3

Tabel 1. Location longitude and latitude (1)

Item	longitude	latitude
assign	100.61239	14.13312
	100.61165	14.13331
	100.61135	14.13311
round1	100.613284	14.13312
	100.611705	14.13311
	100.611128	14.13311
round2	100.612386	14.13312
	100.611709	14.13311
	100.61170	14.13311

Tabel 2. Location longitude and latitude (2)

Item	longitude	latitude
assign	100.612343	14.13318
	100.611196	14.13322
	100.611165	14.13469
round1	100.612316	14.13322
	100.611120	14.13307
	100.611158	14.13384
round2	100.612309	14.133126
	100.611180	14.133159
	100.611150	14.133155

Tabel 3. Location longitude and latitude (3)

Item	longitude	latitude
assign	100.611378	14.13434
	100.612405	14.13432
	100.612384	14.13312
round1	100.613728	14.13432
	100.612397	14.13367
	100.61323	14.13314
round2	100.613808	14.133426
	100.612414	14.133164
	100.612380	14.132457

#### 4. Conclusion

The following are the findings of testing 30 patients with the smart electric wheelchair controlled by a smartphone and controlling the travel path using a GPS: During the first round of testing, GPS and IoT technologies could efficiently navigate the electric wheelchair at 97.66 percent of the assigned route. In the second round of testing, GPS and IoT technologies could efficiently navigate the electric wheelchair at 98.58 percent of the assigned route. 96.45 percent of the time, GPS and IoT technologies could efficiently maneuver the electric wheelchair along the assigned course in the third round of testing. Finally, the test findings of the smartphone-controlled smart electric wheelchair, able to effectively and safely manage movement direction during the voyage

#### Acknowledgments

The authors of this paper are thankful to the ValayaAlongkorn Rajabhat University under the Royal Patronage. Thanks are due to the laboratory.

## References

- [1] S. Chalermchon, and S. Thanutch, Application of GPS Precise point Positioning Technique, International Conference on Engineering Science and Innovative Technology, (2014) 430-436.
- [2] J. Tossaporn, Formal Specification for Vehicle Localization and Monitoring Using GPS and Zigbee Networks, Journal of Research in Engineering and Technology, 4(1) (2007) 27-41.
- [3] P. Amonrat, P. Phuriphong, K. Apichaya, and N. Kantida, Application Development on iOS for Cycling to Travel A Case Study: Phuket Tourism, The Eleventh National Conference on Computing and Information Technology, (2015) 217-222.
- [4] S. Phongphodsawat, and W. Pongpisit, Time Train Tracking System Automatic and Real-Time of GPS based On mobile Case Study for State Railway of Thailand, The Eleventh National Conference on Computing and Information Technology, (2015) 662-667.
- [5] N. Surasak, and T. Siriphan, GPS and Vision-Based Navigation for Intelligent Vehicle, National Conference on Technical Education, (2010) 19-24.
- [6] B. Suthat, P. Phuriphong, J. Buncha, and P. Jantima, A System of Real-time Bus Tracking on Mobile Phone, The Eleventh National Conference on Computing and Information Technology, (2017) 88-93.
- [7] S. Shinde, S. Kumar, and P. Johri, A Review: Eye Tracking Interface with Embedded System & IoT, International Conference Computing, Power and Communication Technology, India, (2018) 791- 795.
- [8] J. C. Ma, C. A. Karl, and A. Dyukov, Certification and Audit of the Intelligent Access Program for the monitoring of heavy vehicles in Australia, IEEE, (2009) 718-721.
- [9] Z. Li, and A. J. Song, Sliding Mode Control Based on Tracking Differentiator for Intelligent Vehicle Headway Distance Control, IEEE, (2009) 489-493.
- [10] J. M. Collado, C. Hilario, A. Escalera, and J. M. Armingol, Model Based Vehicle Detection for Intelligent Vehicle, IEEE, (2004) 572-577.
- [11] T. Ashraf, N. Islam, S. L. Costa, and S. Arefin. Developing an IoT Based Wheelchair: Biomedical Data Logging and Emergency Contingency Services, IEEE, International Conference on Consumer Electronics (ICCE), (2021).
- [12] S. Shinde, S. Kumar, and P. Johri, A Review: Eye Tracking Interface with Embedded System and IoT, IEEE, International Conference on Computing Power and Communication Technoligues (GUCON), (2018)
- [13] S. Soma, N. Patil, and S. F, An Approach to develop a smart and intelligent wheelchair, IEEE, (2018).
- [14] Hayder A. Azeez, Norasmadi Abdul Rahim, Muhammad Juhairi Aziz bin safar, EMG Controlled Wheelchair Movement based on Masseter and Buccinators Muscles, International Journal of Engineering Trends and Technology (IJETT), V37(3) (2016) 133-139. July 2016. ISSN:2231-5381. [www.ijettjournal.org](http://www.ijettjournal.org). published by seventh sense research group.
- [15] D. Devasia, D. R. T.V, and N. S. Jacob, Assistance for Quadriplegic with BCI Enabled Wheelchair and IoT, IEEE, International Conference on Intelligent Sustainable Systems (ICISS), (2020).
- [16] A. Z. Elevado, E. Sagao, and A. F. Sales, Discomfort Monitoring System using IoT Applied to a Wheelchair, IEEE, Internationale Conference on Automatic Control and Intelligent Systems (I2CACIS), (2021).
- [17] AKM. B. Haque, S. Shurid, and A. T. Juha, A Novel Design of Gesture and Voice Controlled Solar-Powered Smart Wheel Chair with Obstacle Detection, IEEE, (2020).